

MENA KARTING CHAMPIONSHIP NATIONS CUP

12-16
DECEMBER 2023

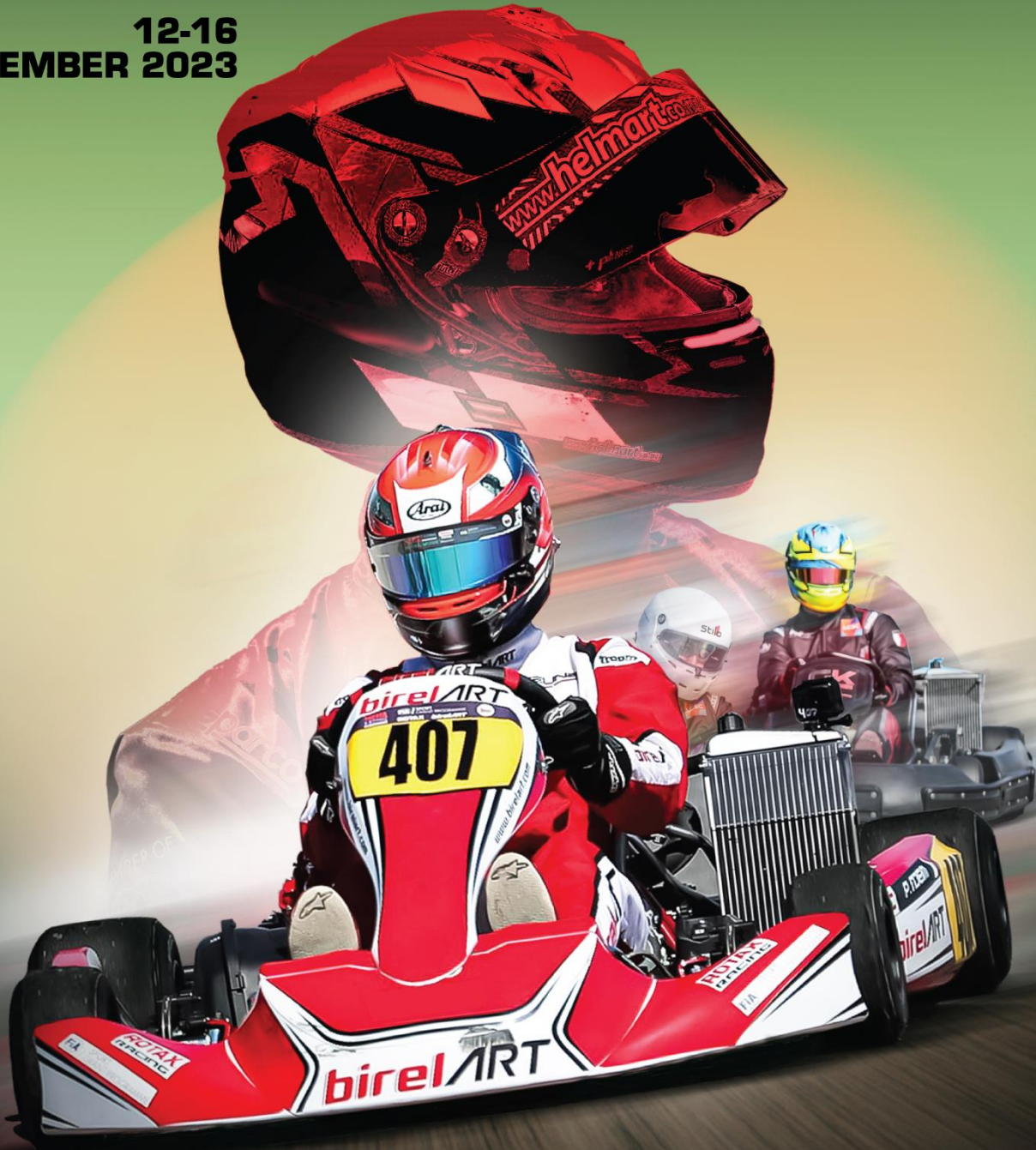

الاتحاد القطري للسيارات والدراجات النارية
QATAR MOTOR & MOTORCYCLE FEDERATION



SPORTING REGULATIONS

وزارة الرياضة والشباب
Ministry of Sports and Youth
دولة قطر • State of Qatar



MEMBER OF



لوسايل
INTERNATIONAL CIRCUIT
طابفة لوسايل الدولية

QATAR
MOTORSPORTS
ACADEMY



MENA KARTING CHAMPIONSHIP NATIONS CUP

Table of Contents

REGULATIONS -----	6
1.1.1 GENERAL-----	6
2 INFORMATION SPECIFIC TO THE CHAMPIONSHIP -----	6
2.1 <i>ORGANISER</i> -----	6
2.1.1 Approvals-----	6
2.1.2 Organiser's name, address and contact details (permanent office)-----	6
2.1.3 Organisation committee-----	6
2.1.4 Stewards of the Meeting-----	6
2.1.5 FIA Delegates & Observer-----	7
2.1.6 Senior officials-----	7
2.1.7 HQ location and contact details-----	7
2.1.8 INSURANCE-----	7
2.1.9 DATE OF EVENT 12-16 DECEMBER 2023-----	8
2.1.10 PROVISIONAL INFORMATION OF THE MEETING-----	8
2.2 <i>ENTRIES</i> -----	8
2.2.1 Reception Office-----	8
2.2.2 Deadlines-----	8
2.2.3 Receipt-----	8
2.2.4 Restriction:-----	8
2.2.5 Fees-----	9
2.2.6 Payments:-----	9
2.3 <i>COMPETITION REQUIREMENTS:</i> -----	9
2.3.1 MENA Rotax MAX Challenge:-----	9
2.3.2 RD1 ELITE Categories:-----	10
2.4 <i>MENA KARTING CHAMPIONSHIP FORMAT</i> -----	10
2.4.1 MENA ROTAX MAX CHALLENGE-----	10
2.4.2 MENA RD1 ELITE ENDURANCE-----	10
2.4.3 MENA RD1 ELITE SPRINT-----	10
2.4.4 Registration-----	11
2.4.5 Scrutineering-----	11
2.4.6 Non-Qualifying Practice-----	11
2.4.7 Formal Welcome Ceremony-----	11
2.4.8 Driver's Briefing-----	11
2.4.9 Qualifying Practice-----	12
2.4.10 Qualifying Heats:-----	12
2.4.11 Pre-Final:-----	12
2.4.12 Final-----	12
2.4.13 Did Not Start (DNS)-----	12
2.4.14 Did Not Finish (DNF)-----	12
2.4.15 Award Presentation-----	13
2.5 <i>POINT SCORING</i> -----	13
2.5.1 MENA Rotax MAX Challenge Ranking Points-----	13
2.5.2 Point Allocation for 'Masters' Drivers-----	13
2.5.3 MENA RD1 ELITE Endurance and Sprint Ranking Points-----	14
2.5.4 MENA Karting Championship Nations Cup (Overall)-----	14
2.5.5 Did Not Start (DNS)-----	14



MENA KARTING CHAMPIONSHIP NATIONS CUP

2.5.6	Did Not Finish (DNF)	15
2.5.7	Penalties	15
2.6	STARTING PROCEDURES	15
2.6.1	General	15
2.6.2	Pre-Grid	15
2.6.3	Formation Lap	15
2.6.4	Race Start (Rolling)	16
2.6.5	False Start	17
2.6.6	Jump Start	17
2.6.7	MENA RD1 ELITE Endurance and Sprint Starting Procedures	17
2.7	RACE NEUTRALISATION (FULL COURSE YELLOW)	17
2.7.1	MENA Rotax MAX Challenge	18
2.7.2	MENA RD1 ELITE Endurance and Sprint	18
2.8	RACE STOPPAGE	19
2.8.1	MENA Rotax MAX Challenge	19
2.8.2	Less than 2 laps complete	19
2.8.3	More than 2 laps but less than 75% complete	19
2.8.4	More than 75% complete	20
2.8.5	– MENA RD1 ELITE Endurance and Sprint:	20
2.9	RACE FINISHING PROCEDURES	20
2.9.1	Weighing Scales	21
2.9.2	Parc Fermé	21
3	CLASSES AND ELIGIBILITY	21
3.1	MICRO MAX	21
3.1.1	Age Limits	21
3.1.2	Weight Limit:	22
3.1.3	Numbers:	22
3.2	MINI MAX	22
3.2.1	Age Limits	22
3.2.2	Weight Limit	22
3.2.3	Numbers	22
3.3	JUNIOR MAX	22
3.3.1	Age Limits	22
3.3.2	Weight Limit	22
3.3.3	Numbers	22
3.4	SENIOR MAX	22
3.4.1	Age Limits	22
3.4.2	Weight Limit	22
3.4.3	Numbers	22
3.5	DD2	23
3.5.1	Age Limits	23
3.5.2	Weight Limit	23
3.5.3	Numbers	23
3.6	DD2 MASTER	23
3.6.1	Age Limits	23
3.6.2	Weight Limit	23
3.6.3	Numbers	23



MENA KARTING CHAMPIONSHIP NATIONS CUP



3.7	MENA RD1 ELITE ENDURANCE AND SPRINT	23
3.8	ENGINES	23
4	SUPPLEMENTARY PROVISIONS – MENA ROTAX MAX CHALLENGE CLASSES ONLY	23
4.1	TYRES	23
4.1.1	Eligible Tyres	23
4.1.2	Quantity of Tyres	23
4.1.3	Pre-Ordering of Tyres	24
4.1.4	Tyre Marking	24
4.1.5	Tyre Collection	24
4.1.6	Tyre Replacement	24
4.2	FUEL	24
4.3	TRANSPONDER	24
4.3.1	Transponder General	24
4.3.2	Transponder Hire/Purchase	24
4.3.3	Transponder Fitting	25
4.3.4	Transponder Failure	25
4.4	RECORDING EQUIPMENT	25
4.5	FLOOR MATS	25
4.6	ENGINE RUNNING	25
5	TECHNICAL REGULATIONS	25
5.1	GENERAL	25
5.2	KARTS	25
6	SAFETY EQUIPMENT	26
6.1	MENA ROTAX MAX CHALLENGE	26
6.2	MENA RD1 ELITE ENDURANCE AND SPRINT	26
6.2.1	Crash Helmet	26
6.2.2	Race Suit	26
6.2.3	Gloves	26
6.2.4	Boots	26
7	REGULATORY AMENDMENTS	26
8	ADVERTISING ON KARTS, OVERALLS AND HELMETS	26
9	USE OF THE TRACK AND OVERTAKING	26
9.1	USE OF THE TRACK	26
9.2	OVERTAKING/DEFENDING	27
9.2.1	General	27
9.2.2	Corner Approach	27
9.2.3	Corner Entry	28
9.2.4	Corner Exit	28
9.3	BEING LAPPED	28



MENA KARTING CHAMPIONSHIP NATIONS CUP



10	GENERAL SAFETY	28
11	CODE OF CONDUCT	29
12	INCIDENTS	30
13	PENALTY CATALOGUE	31
13.1	FALSE START	31
13.2	JUMP START	31
13.3	CUTTING-IN	31
13.4	DIVING UP THE INSIDE	32
13.5	CROWDING, PUSHING or SQUEEZING	32
13.6	BUMPING or CONTACT	32
13.7	SHORT-CUTTING OR EXCEEDING CIRCUIT LIMITS	33
13.8	WEAVING or BLOCKING	33
13.9	TECHNICAL INFRINGEMENT	33
13.10	FORMATION LAP OFFENCES	34
13.11	IGNORING FLAG SIGNALS	34
13.12	CAUSING A COLLISION	34
13.13	FRONT FAIRING MOUNTING KIT	35
13.14	SUMMARY OF PENALTIES	36
14	JUDICIAL MATTERS	37
14.1	STEWARDS HEARINGS	37
14.2	RESPONSIBILITY FOR OFFENCES	37
14.3	WRITTEN WARNING OR REPRIMAND	37
14.4	POINTS PENALTIES	37
14.5	JUDGES OF FACT	38
15	GENERAL PROCEDURES AND INFORMATION FOR MENA RD1 ELITE CLASSES	38
15.1	RD1 ELITE KART INFORMATION	38
15.1.1	Kart Specification	38
15.1.2	Kart Rotation	38
15.1.3	BREAKDOWN RECOVERY AND REPAIR	39
15.2	WEIGHT	39
15.2.1	Minimum Weight	39
15.2.2	Weight Checking Procedure	39
15.2.3	Kart Ballast Weights	40
15.2.4	Practical Weight Considerations	40
15.2.5	Underweight	40
16	THE BELOW ARTICLES REFER TO MENA RD1 ELITE ENDURANCE ONLY	41



MENA KARTING CHAMPIONSHIP NATIONS CUP



16.1	NUMBER OF DRIVERS PER TEAM	41
16.2	ADDITIONAL TEAM PERSONNEL	41
16.3	PIT LANE RULES	41
16.4	REFUELLING	42
16.5	DRIVER CHANGES	42



MENA KARTING CHAMPIONSHIP NATIONS CUP



MENA KARTING CHAMPIONSHIP 2023 SPORTING REGULATIONS

PUBLISHED 13/11/2023

REGULATIONS

The final text of these Sporting Regulations shall be the English version, which will be used should any dispute arise as to their interpretation. Headings in this document are for ease of reference only and do not form part of the regulations.

1.1.1 GENERAL

The Event shall be run in accordance with the requirements of QMMF (incorporating the FIA International Sporting Code and its appendices, the FIA and FIA official Bulletins, the General Prescriptions applicable to FIA Karting International Events, FIA Sporting Regulations 2023, FIA Technical Regulations 2023, the MENA Karting Championship Technical Regulations 2023, these Sporting Regulations and the Supplementary Regulations of the Event). All the parties concerned (FIA, QMMF, Lusail Karting Circuit, ROTAX, Birel ART and entrants) undertake to apply and observe the rules governing this race event.

ANYTHING WHICH IS NOT EXPRESSLY ALLOWED IS FORBIDDEN.

2 INFORMATION SPECIFIC TO THE CHAMPIONSHIP

2.1 ORGANISER

2.1.1 Approvals

ASN registration number: **304-01 QMMF 2023**
FIA Visa: **tba**

Approved on: **06.11.2023**
Approved on: **tba**

2.1.2 Organiser's name, address and contact details (permanent office)

QATAR MOTOR & MOTORCYCLE FEDERATION (QMMF)
Head Quarters in Losail Circuit, Al Wusail, North Relief Road
Phone: +974 4437 9885
Fax: +974 4437 9799 / +974 4437 9761
e-mail: MENA-Karting-Qatar@qmmf.com.qa
website: <http://www.qmmf.com/>

2.1.3 Organisation committee

Chairman	Abdulrahman Al Mannai
Members	Abdulrazaq Al-Kuwari Amro Al-Hamad

2.1.4 Stewards of the Meeting

Chairman	Niroshan Pereira
2 nd Steward	tba
ASN Steward	Natalie Bernard
Secretary to the Stewards	Angelene Lapuz



MENA KARTING CHAMPIONSHIP NATIONS CUP



2.1.5 FIA Delegates & Observer

Observer	tba
Technical Delegate	tba

2.1.6 Senior officials

Race Director	Mark Horsley
Clerk of the Course	Franck Vayssie
Deputy Clerk of the Course	tba
Event Manager	Hassan Turkey
Secretary of the Meet	Angelene Lapuz
Asst. Secretary of the Meet	Nishanti Ravi
Technical Delegate	Shaune English
Chief Scrutineer	Stanley da Silva
Chief Medical Officer (CMO)	Dr. Amr Aboulwafa
Chief Timekeeper	Aaron P. Limbago
Timing System Operator	Isaac Mulungi
Starter	tba
Race Diary Marshal (Incident Report)	Nilendra Nirmani
Race Control Marshal	Jojo Jara
Recovery Marshal	Ely Falisawan
Chief Flag Marshal	Dexter Celemen
Logistics Officer	Rashed Manzur Syed
Media Relations Officer	Fatima Al Qaedi
Local Media Relations Officer	Hunain Ali
Pits/Pitlane/Paddock Coordinator (?)	tba

2.1.7 HQ location and contact details

QATAR MOTOR & MOTORCYCLE FEDERATION (QMMF)
 Losail Karting Circuit, Al Wusail, North Relief Road
 Phone: +974 4437 9885
 Fax: +974 4437 9799 / +974 4437 9761
 e-mail: MENA-Karting-Qatar@qmmf.com.qa
 website: <http://www.qmmf.com/>

2.1.8 INSURANCE

The company providing the third party liability insurance cover is:

TBA

Policy Number: TBA

Third party insurance arranged by the organiser shall be in addition and without prejudice to any personal insurance policy held by the competitor or any other participant in the event. Competitors participating in the 2023 MENA Karting Championship are not third parties in respect to one another.



MENA KARTING CHAMPIONSHIP NATIONS CUP



2.1.9 DATE OF EVENT 12-16 DECEMBER 2023

12	DEC 2023	ADMINISTRATION & PRELIMINARY DRIVERS BRIEFING
13	DEC 2023	PRACTICE (4 X 15 MINUTE SESSIONS PER CATEGORY)
14	DEC 2023	FIA "United Against Online Abuse" PRESENTATION PRACTICE (3 X 15 MINUTE SESSIONS PER CATEGORY). SCRUTINEERING, TYRE ALLOCATION, & WELCOME CEREMONY
15	DEC 2023	RACE DAY 1 - MANDATORY DRIVERS BRIEFING, QUALIFYING & HEATS (3 HEATS FER CLASS)
16	DEC 2023	RACE DAY 2 - WARM-UP, PRE-FINALS, FINALS & AWARDS CEREMONY

2.1.10 PROVISIONAL INFORMATION OF THE MEETING

This is according to the circuit license and event permit, sanctioned by QMMF. Additional information will be available in the Supplementary Regulations for the event. A detailed time schedule will be issued in advance and displayed on the official Notice Board. The organisers reserve the right to alter the time schedule at any time. Confirmed entrants will be immediately notified of any necessary amendments. The complete Driver's Information document can be found on the [QMMF Website](http://www.qmmf.com).

2.2 ENTRIES

2.2.1 Reception Office

QATAR MOTOR & MOTORCYCLE FEDERATION (QMMF)
P.O. BOX 8708
Phone: +974 4437 9885
Fax: +974 4437 9799 / +974 4437 9761
e-mail: mena-karting-qatar@qmmf.com.qa
Website: <http://www.qmmf.com>

2.2.2 Deadlines

A correctly completed Entry Form and all mandatory documents must be received by the close of business on Monday 25th November 2023. The Organisers reserve the right to refuse entries submitted after this deadline.

2.2.3 Receipt

Any entry not accompanied by the total fees and complete documentation shall be null and void (see 2.2.5)

2.2.4 Restriction:

Maximum entries apply in all classes. Entry will be accepted in the order of receipt.



MENA KARTING CHAMPIONSHIP NATIONS CUP



2.2.5 Fees

2.2.5.1 Standard Race Fees

RMC Classes (up to 6 drivers per ASN)

- 500 QR per driver
- 15000 QR for each additional driver

RD 1 Elite Endurance Class (up to 2 teams per ASN)

- 500 QR per team
- 2500 QR for each additional team

RD 1 Elite Sprint Class (up to 3 drivers per ASN)

- 250 QR per driver
- 1250 for each additional driver

Independent Category Fees (MENA Region eligible drivers)

- 20000QR per driver per category in MENA RMC
- 2500QR per team in MENA RD1 ELITE ENDURANCE
- 1250QR per driver in MENA RD1 ELITE SPRINT

Supplementary Fees (optional):

- | | |
|---|----------|
| ➤ Transponder hire | QAR 150 |
| ➤ Tyres Micro/Mini MAX (per set) | QAR 900 |
| ➤ Tyres Junior MAX, MAX and DD2 (per set) | QAR 1200 |
| ➤ Tyre fitting (per set) | QAR 120 |

2.2.6 Payments:

Payments should be made (in full according to 2.4.2, 2.4.3 and 2.4.5) by direct transfer to:

Bank Name: QATAR NATIONAL BANK
Account Number: QATAR MOTOR & MOTORCYCLE FEDERATION
Account Number: 0013-009860-002
IBAN: QA14 QNBA 0000 0000 0013 0098 6000 2
Swift: QNBAQAQA

2.3 COMPETITION REQUIREMENTS:

2.3.1 MENA Rotax MAX Challenge:

- Drivers must be in possession of a valid National or International Kart License issued by a recognised ASN. If the Entrant is other than the driver, then the entrant must hold a separate valid Entrant License issued by the same authority.
- All competitors must gain "Start Permission" from their license issuing ASN. All competition licenses must be surrendered at signing on (along with the start permission paperwork) for verification. Failure to produce the required documentation will result in enforced non-participation.



MENA KARTING CHAMPIONSHIP NATIONS CUP



- C. Only MENA Nationals will be eligible to score “MENA Nations Cup” points in MENA RMC categories. Competitors must hold a valid passport issued by the country of representation. An ASN may add additional drivers beyond the prescribed limit on a first-come-first-served basis, subject to availability and organiser approval.
- D. Age limits according to Article 3.

2.3.2 RD1 ELITE Categories:

- A. Drivers do not need to be in possession of a valid Kart Competition License, but participants are required to have significant karting or motorsport experience.
- B. Competitors must be a minimum of 15 yrs. of age and a minimum weight of 55kg. Drivers aged 14 yrs. are eligible to compete if they (1) weigh a minimum of 55kg and (2) are in possession of a valid National or International Kart License issued by a recognised ASN.
- C. Entry is open to all but only MENA Nationals are eligible to score “MENA Nations Cup” points in RD1 ELITE SPRINT and ENDURANCE (to score points in ENDURANCE ALL team drivers must hold a valid passport issued by the country of representation).

2.4 MENA KARTING CHAMPIONSHIP FORMAT

2.4.1 MENA ROTAX MAX CHALLENGE

- Registration
- Kart Raffle
- Scrutineering
- Non-Qualifying Practice
- Welcome Ceremony
- Driver’s Briefing
- Qualifying
- 3x Heats
- Pre-Final
- Final
- Award presentation

2.4.2 MENA RD1 ELITE ENDURANCE

- Registration
- Welcome Ceremony
- Driver’s Briefing
- Practice/Qualifying
- 2HR Endurance Race
- Award presentation

2.4.3 MENA RD1 ELITE SPRINT

- Registration
- Welcome Ceremony
- Driver’s Briefing
- Practice/ Qualifying
- Pre-Finals
- Final
- Award presentation

Detailed descriptions of each element of the event format can be found below. Any deviation for



MENA KARTING CHAMPIONSHIP NATIONS CUP



RD1 ELITE categories will be explained in the respective Driver's Briefings. See also Driver Information document.

2.4.4 Registration

Registration will commence at the beginning of the event at the time stipulated in the Official Timetable and/or Supplementary Regulations.

Drivers must present their valid racing licence and all associated paperwork to be verified by the administration team before being allowed to sign on. Drivers who are unable to produce a valid licence or proof thereof will be referred to the Stewards and may not be permitted to take part in the race meeting.

The event Organiser and the Stewards will control all licences during the event.

For drivers under 18 years, a countersignature is required from a parent or legal guardian. If a parent is not available to sign, he/she must authorise another individual (over 18yrs) to act as the legally responsible adult by obtaining the relevant paperwork IN ADVANCE and submitting it to the organisation as part of the race entry.

Additionally, and optionally, a representative (entrant) may be nominated to accompany the driver at briefings and judicial hearings instead of the parent (Article 14.1). This individual MUST also submit their signature at signing on and MUST attend the Driver's Briefing.

2.4.5 Scrutineering

Scrutineering will take place in a predetermined area and at the time specified in the Official Timetable and/or Supplementary Regulations. Drivers must present themselves along with their race-wear and equipment (which must be ready to race) to the Scrutineers at the allotted time for a basic safety and technical compliance inspection.

Drivers who do not successfully pass Scrutineering will not be permitted to take part in the race meeting. A driver shall not be allowed to change his/her equipment after it has been identified at Scrutineering without the express permission of the Scrutineers.

If any kart is dismantled or modified in a way that might affect its safety or call into question its eligibility, or which is involved in an accident with similar consequences, it must be re-presented for scrutineering inspection and approval.

Note: Post-race scrutineering will be conducted at the discretion of the Chief Scrutineer in conjunction with other Senior Race Officials. Drivers are solely responsible for the technical compliance of their kart, engine and race wear at the time of inspection.

2.4.6 Non-Qualifying Practice

The Official Timetable provides details on the number and duration of non-qualifying sessions for each MENA RMC category. These sessions are reserved for those drivers who have passed the sporting checks and scrutineering. The use of transponders is mandatory from the beginning of non-qualifying practice.

2.4.7 Formal Welcome Ceremony

In acknowledgement of all Nations, Teams and Drivers taking part in the MENA Karting Championship a formal Welcome Ceremony will take place on Thursday 14th December 2023. All MENA-registered competitors are required to be in attendance.

2.4.8 Driver's Briefing

Entrants and Drivers Briefings are meetings organised by the Race Director for all Entrants and Drivers entered in the event. The presence of all drivers and drivers' representatives (as dictated by the signing on paperwork) is mandatory throughout the Briefings under pain of a sanction,



MENA KARTING CHAMPIONSHIP NATIONS CUP



including disqualification from the event. Attendance will be monitored and recorded. The aim of each Briefing is to remind Entrants and Drivers of points concerning safety and organisation, whether general or specific, and to provide clarification concerning the interpretation of the regulations. Briefing timings are specified in the Official Timetable. Additional meetings may be organised if this is deemed necessary. Details will be posted on the official Notice Board.

2.4.9 Qualifying Practice

The length of this session will be stipulated in the event Supplementary Regulations. All competitors must leave the Pre-Grid at the time of the green flag and complete a minimum of ONE TIMED lap (excluding warm up and cool down laps). Once a driver enters the Pit Lane their session is deemed to be over. The result of this session will determine the starting positions for the Heats in terms of best lap time classification. In the case of 2 drivers achieving identical best lap times, the Organisers will revert to the second-best lap time set by each individual in order to determine priority, and so on. Failure to participate in this session may result in disqualification from the remainder of the event. Drivers failing to complete the minimum specified distance may be referred to the Stewards.

2.4.10 Qualifying Heats:

Drivers will compete in 3 Qualifying Heats. The race duration (in laps) for each category will be specified in the event Supplementary Regulations. The winner of the Heat is the driver completing the stipulated quantity of laps in the shortest time. All drivers crossing the start/finish line behind him/her will be deemed to have finished the race regardless of the number of laps they have completed. Drivers completing the same number of laps will be classified in the order in which they cross the finish line. The aggregated results of the Qualifying Heats will determine starting positions for the Pre- Final. In the case of a tie, priority will be given to the driver with the greatest number of 1st places. If the number of 1st places is equal then the greatest number of 2nd places will be used, and so on until a winner emerges.

2.4.11 Pre-Final:

The length of this race (laps) will be specified in the event Supplementary Regulations. The winner of the Pre-Final is the driver completing the stipulated quantity of laps in the shortest time. All drivers crossing the start/finish line behind him/her will be deemed to have finished the race regardless of the number of laps they have completed. Drivers completing the same number of laps will be classified in the order in which they cross the finish line. The results of the Pre-Final will determine the starting positions for the Final.

2.4.12 Final

The length of this race (laps) will be specified in the event Supplementary Regulations. The winner of the Final is the driver completing the stipulated quantity of laps in the shortest time. All drivers crossing the start/finish line behind him/her will be deemed to have finished the race regardless of the number of laps they have completed. Drivers completing the same number of laps will be classified in the order in which they cross the finish line. The final classification of the event will be the classification of the Final.

2.4.13 Did Not Start (DNS)

DNS is used to classify any driver who fails to cross the start line at the time of the start signal. See also 2.5.5.

2.4.14 Did Not Finish (DNF)

DNF is used to describe any driver who fails to cross the finish line to receive the chequered flag.



MENA KARTING CHAMPIONSHIP NATIONS CUP



In this case, drivers will be classified in the order of the number of laps completed. See also 2.5.6. Drivers completing the same number of laps will be classified in the order in which they last crossed the finish line.

2.4.15 Award Presentation

Awards will be presented to the top drivers in each class according to the official finishing positions in the Final. Results do not become official until 30 minutes "protest time" has elapsed without objection. Prize winners are to ensure that race suits are worn and zipped up with collar closed. Race boots should also be worn. See also section 8.

2.5 POINT SCORING

2.5.1 MENA Rotax MAX Challenge Ranking Points

Nations Cup ranking points for MENA Rotax MAX Challenge are awarded as follows:

POSITION	MENA ROTAX MAX CHALLENGE					
	Q	H1	H2	H3	PF	F
1	5	20	20	20	35	50
2	4	18	18	18	30	40
3	3	16	16	16	26	35
4	2	14	14	14	23	31
5	1	12	12	12	21	28
6	-	10	10	10	20	26
7	-	9	9	9	19	25
8	-	8	8	8	18	24
9	-	7	7	7	17	23
10	-	6	6	6	16	22

And so, on down to last place finisher...

Only the highest scoring driver for each country in each MENA RMC race (in accordance with Article 2.5.1) will score points towards the Team Nations Cup ranking total.

2.5.2 Point Allocation for 'Masters' Drivers

DD2 and DD2 Master competitors share the same grid and overall points are awarded according to the above points system. Drivers meeting 'DD2 Master' requirements (see Section 3 – Classes and Eligibility) will also take their respective point totals into a separate DD2 Master classification. For example, a DD2 Master driver finishing a Qualifying Heat in 3rd place overall will receive 16 points in the overall DD2 classification and also carry these 16 points into the DD2 Master classification with all other DD2 Master drivers.



MENA KARTING CHAMPIONSHIP NATIONS CUP



2.5.3 MENA RD1 ELITE Endurance and Sprint Ranking Points

Nations Cup ranking points for MENA RD1 ELITE categories are awarded as follows:

POSITION	MENA RD1 ELITE				
	ENDURANCE		SPRINT		
	Q	R	Q	PF	F
1	15	100	15	35	50
2	14	90	14	30	40
3	13	80	13	26	35
4	12	70	12	23	31
5	11	60	11	21	28
6	10	50	10	20	26
7	9	45	9	19	25
8	8	40	8	18	24
9	7	35	7	17	23
10	6	30	6	16	22
And so on down to last place finisher...					

Only the highest scoring 1 Driver (Sprint) and 1 Team (Endurance) for each country per session (in accordance with Article 2.5.2) will score points towards the Team Nations Cup ranking total.

2.5.4 MENA Karting Championship Nations Cup (Overall)

Each registered MENA Karting Championship competitor will accumulate MENA Karting Championship Nations Cup Ranking Points for their country of representation throughout the event according to Articles 2.5.1, 2.5.2, 2.7.1 and 2.7.2.

For any sessions which are cancelled or abandoned due to "force majeure," no ranking points will be awarded. Points scored in each of the disciplines will be recorded and accumulated to make an ultimate MENA Karting Championship Nations Cup Total for each MENA Nation.

In the case of 2 or more Nations finishing the event with the same number of points, the higher placing will be awarded to the Nation with the greatest number of 1st places in Finals (including the MENA RD1 ELITE Endurance). If the number of 1st places is equal then the greatest number of 2nd places will be used, and so on until a winner emerges. If this procedure fails to produce a result, Pre-Finals will be reviewed in the same way (greatest number of 1st places in Pre-Finals followed by the greatest number of 2nd places, etc.). The top 3 MENA Nations will be rewarded with trophies at the Awards Presentation on Saturday 16th December 2023 with the overall winner being declared the MENA Nations Cup Champion 2023!

2.5.5 Did Not Start (DNS)

For each race (Heat, Pre-Final and Final) the number of ranking points awarded equates to 5 points less than the last classified MENA finisher, down to a minimum of zero points (see also Article 2.4.13).



MENA KARTING CHAMPIONSHIP NATIONS CUP



2.5.6 Did Not Finish (DNF)

In the case of a DNF in any ranking points race, the number of points awarded will be determined by the driver's classified position among MENA drivers (see also Article 2.4.14)

2.5.7 Penalties

Drivers receiving a black flag may be subject to further penalties including, but not limited to, ranking point deductions and fines (see also Articles 12 and 13). Penalties will apply under ISC Article 12.4 – Scale of Penalties.

2.6 STARTING PROCEDURES

The following procedures apply to MENA ROTAX MAX CHALLENGE classes only. For MENA RD1 ELITE SPRINT AND RD1 ELITE ENDURANCE please refer to Article 2.6.7.

2.6.1 General

The regulations for "Rolling starts for direct drive karts with or without clutches" of the FIA Karting General Prescriptions apply. Kart trolleys will not be permitted onto the circuit from the moment the karts leave the Grid to the time all running karts have returned to the pits following the chequered flag.

2.6.2 Pre-Grid

Karts shall be lined up on the Pre-Grid as detailed in section 2.6. It is the driver's responsibility to ensure that both he/she and their kart are in position on the Pre-Grid before the Pre-Grid closes. Any drivers arriving after this time will not be permitted to enter the circuit without the express permission of the Clerk of the Course.

Only one helper (mechanic) is permitted to accompany the driver/kart onto the Pre-Grid. Other than that, the Pre-Grid is out of bounds to all personnel who are not operating in an authorised capacity as signed-on Officials. Karts placed on the Pre-Grid must be ready to race. It is strictly forbidden to carry out any work and/or set-up on the kart on the Pre-grid with the exception of tyre pressures, which can be adjusted by the driver or his/her mechanic and by using his/her own means.

Anyone wishing to carry out work after the kart has been placed on the Pre-Grid must completely remove the kart beyond the last placed kart on the Pre-Grid before carrying out such work. Mechanics must clear the Pre-Grid 1 min before the start of the Race ("1 minute" board). 30-seconds after the "30 seconds" board is displayed the green flag will be shown at the front of the grid to indicate that the karts must proceed onto the circuit to either commence Practice/Qualifying or to begin a Formation Lap.

Should a driver require assistance after the green flag is shown a mechanic may only work on the kart once the other karts have left the Pre-Grid. If a driver is unable to start from the Pre-Grid at the time of the green flag, he/she will only be authorised to join the circuit on the orders of the Clerk of the Course.

2.6.3 Formation Lap

Drivers should leave the Pre-Grid when the green flag is displayed.

The field must stick together in 2 distinct lanes as per the positions on the Pre-Grid. It is the responsibility of the driver in Pole Position to set the pace, which should be steady and controlled. The driver in 2nd position should remain alongside during this lap.



MENA KARTING CHAMPIONSHIP NATIONS CUP



Drivers must not break formation before taking the start (see 2.6.4). Erratic weaving (zig- zags) is prohibited. Offending drivers will be penalised. There is only one Formation Lap unless otherwise indicated during the Briefing. It is forbidden to overtake another driver under pain of a penalty inflicted by the Stewards. If a driver stops for any reason during the Formation Lap and the kart cannot be restarted quickly, it must be immediately removed from the track to a place of safety.

A driver who is otherwise delayed and finds themselves out of position will have the possibility of regaining his/her place (1) only if this manoeuvre does not impede other drivers and (2) in all cases before having reached their original starting position by the point of crossing the Red Line which will be marked on the track and indicated by the Clerk of the Course during the Briefing.

Drivers are cautioned that they should remain at the back of the field if the manoeuvre cannot be safely completed by the red Formation Line. In order to regain one's position, it is forbidden to use any course other than the track used during the race.

Any driver permitted to join the track AFTER a false start MUST remain at the back of the grid on the current formation lap and any subsequent formation lap until the race is officially started. See also 2.6.5.

It is the responsibility of Pole Position to keep the field at walking pace from the red formation line up until the tramlines in the interests of safety. Anti-Pole must ensure that he/she is not ahead of Pole Position at the time the start signal is given.

DD2 competitors should remain fixed in 1st gear from the red line up until the start signal is given.

Additional Formation Laps required due to aborted starts may be deducted from the race distance at the discretion of the Clerk of the Course.

2.6.4 Race Start (Rolling)

At the end of the Formation Lap, drivers will proceed forward in two lines at a reduced and constant speed towards the Starting Line, as dictated by the front row. Each line of karts shall remain within the 110m long corridor (tramlines) marked on the track.

When the karts approach the Start Line the red lights will be on. Karts must maintain their position until the start signal is given. A driver crossing the tramlines is liable to be sanctioned by the Stewards on the basis of a time penalty of 3 seconds for partially crossing the lines and 10 seconds for completely leaving the corridor.

If he/she is satisfied with the formation, the Starter will give the start by switching off the red lights. If he/she is not satisfied with the procedure flashing amber lights will be activated (with the red lights) to indicate a "no-start", meaning that an extra Formation Lap will take place. If the reason for a "no-start" is due to a particular offender, Officials may decide to impose a penalty at their discretion.

If he considers that a driver has been immobilised as a result of another driver's mistake, the Clerk of the Course may stop the Formation Lap and recommence the Starting Procedure on the basis of the original grid or allow the impeded driver to regain his/her position. In the case of start light failure, the National flag will be used. The flag will be held out stationary on the approach and raised to indicate a start.

As soon as the start signal has been given racing conditions are applied.

The Clerk of the Course assumes responsibility for determining the safest way to deal with stranded karts/drivers once the race is live. Under his direction the marshals will sometimes assist driver(s) to a place of safety before transferring the kart(s) to a safe position although it



MENA KARTING CHAMPIONSHIP NATIONS CUP



should be noted that this is the driver's responsibility. Alternatively, in certain circumstances he may (in the interests of safety) direct that karts are separated/manoeuvred so that the drivers can continue. Only registered officials may assist.

2.6.5 False Start

A false start will be indicated by one or both of the following:

- A. A flashing amber "first corner light"
- B. A false start flag (green with yellow chevron) displayed after the Start Line In either of these circumstances, competitors are expected to raise one arm in acknowledgement of the false start before slowing and organising themselves into their original starting positions to attempt a restart at the next opportunity. Any competitors forced to take the [false] start out of position following a pre-grid or formation lap delay may not assume their original grid position. Drivers permitted to join the grid AFTER a false start MUST remain at the back of the field until the race is officially started.

2.6.6 Jump Start

Any attempts to jump the start or delay it and any karts leaving the lane (rolling start) or grid slot (standing start) before the lights are switched off shall be sanctioned according to Article 13.2 (in line with Article 2.24 of the FIA Karting General Prescriptions).

2.6.7 MENA RD1 ELITE Endurance and Sprint Starting Procedures

The following procedures apply to the start of the MENA RD1 ELITE Endurance Race and the MENA RD1 ELITE Sprint Pre-Final and Final:

Karts will be released from the Pit Lane in Qualifying order to start a single-file Formation Lap which will be steady and controlled behind Pole Position. The Pole-sitter must keep his engine at constant speed during this lap (7000rpm is recommended if conditions allow).

Drivers must not break formation before taking the start. At the end of the Formation Lap, drivers will proceed forward in ONE line up the middle of the track (in between both sets of tramlines) at a reduced and constant speed towards the Starting Line, as dictated by Pole Position. Red lights will be on to indicate the Starter is ready. If satisfied with the formation, the Starter will switch off the red lights. If he/she is not satisfied with the procedure flashing amber lights will be activated (with the red lights) to indicate a "no-start". A false start flag will also be displayed meaning that an extra Formation Lap will take place. If the reason for a "no-start" is due to a particular offender, the Race Director may decide to impose a penalty at his discretion.

If he considers that a driver has been immobilised as a result of another driver's mistake, the Race Director may stop the Formation Lap and recommence the Starting Procedure on the basis of the original grid or allow the impeded driver to regain his/her position. In the case of start light failure, the National flag will be used. The flag will be held out stationary on the approach and raised to indicate a start.

Breaches of the starting procedure will result in penalties being applied.

2.7 RACE NEUTRALISATION (FULL COURSE YELLOW)



MENA KARTING CHAMPIONSHIP NATIONS CUP



2.7.1 MENA Rotax MAX Challenge

The Clerk of the Course may decide to 'neutralise' a Race or Qualifying session by directing that a *full course yellow* be issued. This procedure can be used where the track is obstructed and/or drivers and officials are in immediate physical danger BUT the circumstances are insufficient to justify a stoppage (see Article 2.8).

Simultaneously, yellow/black quartered flags will be shown at all Marshals' Posts, accompanied by a 'SLOW' board where available. Yellow warning lights will be activated at circuits with this capability. The race leader's number will be displayed at the start line. [At venues where yellow/black flags are unavailable, **stationary** yellow flags will be used.]

The leading kart will dictate the pace but must slow sufficiently to allow all karts behind to catch up and form a long train. The formation should then remain as tight as possible with no overtaking permitted (unless a kart slows dramatically or stops because of a problem).

At the end of the neutralisation, the Clerk of the Course will call for the yellow lights to be switched off. A waved green flag at the Start Line will signal the resumption of the race. Green flags will then be shown at all Marshal Posts for a maximum of 1 lap.

Drivers should remain in single file and in between the tramlines on the approach to [the green flag at] the Start Line and may accelerate only after crossing the yellow line. Overtaking remains prohibited until crossing the Start Line at the time of the green flag.

Each lap completed during the neutralisation will be counted as a racing lap. If the race finishes during the neutralisation, the karts will take the chequered flag as usual.

2.7.2 MENA RD1 ELITE Endurance and Sprint

The following procedures apply to race neutralisation (full course yellow) during MENA RD1 ELITE Endurance and MENA RD1 ELITE Sprint sessions:

In case of any incident on the track where a kart requires recovery or the safety of marshals is at risk, the Race Direction may elect to neutralise the race by means of a 'full course yellow'. In this situation all marshals will hold yellow/black quartered flags stationary to indicate to drivers that yellow flag rules apply to the entire circuit. Yellow lights may also appear around the circuit.

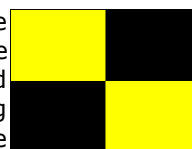

The number of the leading kart will be shown together with a yellow/black quartered flag at the start line. It is the responsibility of the leading kart/driver to reduce speed sufficiently so as to allow all karts to line up behind in a train, without breaking formation. The procession will continue while the track officials carry out necessary work to return the circuit and its elements back to normal in order to continue the race safely. Note that during this time it is likely that recovery vehicle(s) may be on the circuit. It is imperative that all drivers pay full attention to the condition of the circuit and the presence of officials at all times - despite the relatively slow pace. Drivers should take care to adjust their driving and throttle control in order to avoid the spark plug 'fouling'. Drivers will be allowed to keep to a medium but consistent pace while slowing appropriately through the incident zone.

For RD1 ELITE Endurance Race only the Pit Lane will remain open throughout the full course yellow period for driver changes and refuelling. However, delays are possible at the Pit Exit since karts may only be allowed to rejoin after the last competitor in the pack has passed pit exit.

Once the incident has been cleared to the satisfaction of the Race Director, a green flag will be shown at the Start Line and all subsequent marshal posts to indicate that racing speed can be resumed. Karts may only overtake once they have crossed the Start Line after the green flag is displayed.



MENA KARTING CHAMPIONSHIP NATIONS CUP



2.8 RACE STOPPAGE

2.8.1 MENA Rotax MAX Challenge

Should it become necessary to stop a Race or Practice because the circuit is blocked by an accident or because weather or other conditions make it dangerous to continue, the Clerk of the Course or the Race Director shall order a red flag to be shown at the Start Line. Simultaneously, red flags will be shown at all Marshals' Posts. The decision to stop the race or practice may be taken only by the Clerk of the Course (or by his deputy) or the Race Director. If the signal to stop racing is given all karts will immediately reduce their speed and come to a stop on the track at the place designated during the Briefing, considering that the classification of the Race will be the classification at the end of the lap prior to that during which the signal to stop was given. The procedure to be followed varies according to the number of laps completed by the Race leader before the signal to stop was given:

2.8.2 Less than 2 laps complete

Any race stopped before the leader has completed 2 laps will be declared null and void. The race will be re-run in its entirety. All available karts will restart from their original grid positions. Front fairings may be reset without the mandatory penalty [Article 13.13], but drivers are still culpable for any driving offences committed during the abandoned race).

2.8.3 More than 2 laps but less than 75% complete

If more than 2 laps but less than 75% of the distance scheduled for the Race has been completed by the leader (rounded up to the nearest whole higher number of laps), the Clerk of the Course shall, at his discretion, decide to:

- Abandon the race. In this case the race result shall be declared as the finishing order behind the leader on the last full lap completed by him/her and before the race was stopped.
- Consider the race suspended and run it as a two-part race. In this case, the Race will be restarted as a single file rolling start (in between the tramlines) with no overtaking before the start line. The starting order of the second part of the race shall be the running order at the end of the last full lap completed by all karts before the race was stopped, while taking into account any time penalties (see Article 13.13). Drivers "one lap down" shall be put in their correct position behind the drivers on the lead lap. The race distance shall be the number of laps required to make up the full race distance. The finishing order of the second part shall be the finishing order of the race.

Drivers "one lap down" in the first part shall be deemed to have finished the race 1 lap down unless they 'unlap' themselves. While racing is stopped, the whole course shall be considered as Parc Fermé and no work may be carried out on any kart (except to reset the front fairing in the correct position under the supervision of the Scrutineers). No one may enter the circuit without the express permission of the Clerk of the Course.

If a kart leaves the circuit during the stoppage, it will not be permitted to re-join the race. Any kart not racing before the incident (that caused the stoppage) shall not re-join the restarted race.

Karts involved in the incident that gave rise to the stoppage, or who subsequently stopped racing prior to the displaying of the red flag, may only re-join the race if the Clerk of the Course, in consultation with the Chief Scrutineer, is satisfied that a kart is safe to continue without repair, and the Chief Medical Officer is satisfied that a competitor is fit to continue racing. Any such individual must restart at the rear of the field.

All other karts may take the restart in their appropriate position.



MENA KARTING CHAMPIONSHIP NATIONS CUP



Exceptionally, if it becomes necessary to remove all karts from the circuit before the restart, Parc Fermé conditions apply and no work or repair may be carried out without the express consent of the Chief Steward or Clerk of the Course. This will be discretionary.

2.8.4 More than 75% complete

If 75% race distance or more has been completed by the leader (rounded up to the nearest whole higher number of laps), the Race will be deemed to have ended. The race result shall be declared as the finishing order behind the leader on the last full lap completed by him/her and before the Race was stopped.

2.8.5 – MENA RD1 ELITE Endurance and Sprint:

Should it become necessary to stop the Race (or Practice or Qualifying) because the circuit is blocked by an accident or because weather or other conditions make it dangerous to continue, the Race Director shall order a red flag to be shown at all marshal posts.



All karts will immediately reduce their speed and proceed towards the Start Line. **Once the Red Flag is displayed overtaking is not allowed.** Karts must keep to one side of the track on the main Start/Finish straight and come to a complete stop before reaching the Start Line. Karts must line up in single file and drivers should remain in their karts until advised by the Race Direction so as not to constitute an obstruction. Engines should be switched off.

PARC FERME CONDITIONS APPLY. Drivers may return to the pits only if directed to do so by the officials. ONLY Race Officials are allowed on the track or near the karts at any time unless otherwise instructed by the Race Director. Exceptionally, if it becomes necessary to remove all karts from the circuit before a restart, Parc Fermé conditions apply and no work or repair may be carried out without the express consent of the Race Director. This will be discretionary.

Before the race resumes, and when it is considered safe to do so, all drivers on the starting grid in front of the race leader will be permitted to drive under full course yellow conditions around the circuit to line up at the back of the train. The race leader will then lead all karts round under full course yellow conditions until the green flag is shown (see 2.9.2).

The Race Director will determine whether the race will be abandoned, continued or declared according to the specific circumstances of the stoppage. If declared the race result shall be the finishing order behind the leader on the last full lap completed by him/her and before the Race was stopped.

2.9 RACE FINISHING PROCEDURES

The following procedures apply to MENA Rotax MAX Challenge categories as well as MENA RD1 ELITE Endurance and MENA RD1 ELITE Sprint.

A. The chequered flag signal indicating the end of the Race shall be given on the Start Line as soon as the leading kart has covered either the full race distance or the greatest distance during the time scheduled for the race.

B. Should the signal indicating the end of the race be given before the leading kart completes the scheduled number of laps or before the prescribed time has elapsed, the race will be deemed to have finished when the leading kart last crossed the Line before the signal was given.

Should the signal indicating the end of the race be delayed for any reason, the Race will be deemed to have finished when, under normal circumstances, the end of the race would have been decided if there had been no delay.

C. After having received the chequered flag, all karts shall directly go to the scales (and Parc Fermé) using the normal course of the track, without any unnecessary delay, without performing doughnuts, without stopping, without giving or receiving any object whatsoever and





MENA KARTING CHAMPIONSHIP NATIONS CUP



without any help (except that of Marshals if necessary).

Any classified kart unable to reach the scales by its own means will be placed under the control of Marshals, who will supervise the movement of the kart to the scales with the assistance of the driver.

D. For a finish to be considered valid, a driver must have crossed the Finish Line seated at the wheel of his/her kart and under his/her own power.

E. Any driver removing both hands from the steering wheel whilst travelling at considerable speed, whether in celebration or not, will be adjudged to be driving without due care and will be referred to the Stewards.

F. In the case of a dead heat on the Finish Line revealed by timekeeping, the rule for deciding between tying drivers shall be the fastest lap time recorded by each driver during the race concerned.

2.9.1 Weighing Scales

The official weighing scales will be situated in Parc Fermé unless otherwise stipulated by the circuit licence.

The Chief Scrutineer will be the judge of fact in all post-race weigh-ins. If a competitor is found to be underweight, the Chief Scrutineer will issue a report to the Chief Steward based on the series of weighing measurements taken in Parc Fermé. Any final decision relating to classification in this instance will be taken by the Chief Steward.

2.9.2 Parc Fermé

Only authorised Officials may enter Parc Fermé. No intervention of any kind is allowed there unless authorised by such Officials.

When Parc Fermé is in use, Parc Fermé regulations will also apply in the area between the finishing line and the Parc Fermé entrance.

Any driver returning to Parc Fermé either during or after a race (for whatever reason) must report to the scales for weight verification.

Drivers are not permitted to leave Parc Fermé until expressly permitted by the Officials.

3 CLASSES AND ELIGIBILITY

3.1 MICRO MAX

3.1.1 Age Limits

Age range 8-11 yrs.

Competitors must have their 8th birthday during the year of the event (or before) and their 12th birthday after 31st December 2023.

Please note that, at the time of writing, eligibility for Micro MAX in 2023 is likely to rest only with drivers born after 1st January 2012 although this is subject to change according to the host country's ASN and is outside the control of the organisation.



MENA KARTING CHAMPIONSHIP NATIONS CUP



3.1.2 Weight Limit:

Minimum weight of kart + driver (in full race gear) is **105 kg**
Recommended minimum driver weight is 24kg

3.1.3 Numbers:

Yellow plate (22cm sides) with black numbers (at least 15cm high with 2cm stroke) Range of numbers 1 to 99.

3.2 MINI MAX

3.2.1 Age Limits

Age range 10-13 yrs.

Competitors must be at least 10 years of age and have his/her 14th birthday after 31st December 2023.

Please note that, at the time of writing, eligibility for Mini MAX in 2023 is likely to rest only with drivers born between 1st January 2010 and 31st December 2013 although this is subject to change according to the host country's ASN and is outside the control of the organisation.

3.2.2 Weight Limit

Minimum weight of kart + driver (in full race gear) is **115 kg**
Recommended minimum driver weight is 32kg

3.2.3 Numbers

Yellow plate (22cm sides) with black numbers (at least 15cm high with 2cm stroke) Range of numbers 100 to 199.

3.3 JUNIOR MAX

3.3.1 Age Limits

Age range 12-15yrs

Competitors must have their 12th birthday before 31st December 2022 and 16th birthday during/after 31st December 2023.

Drivers under the age of 12 years are eligible to compete if they are at least 145cm in height and 40kg in weight and conform to the above birthdate restrictions.

Drivers turning 15 years of age during 2022 can only be eligible for Junior MAX in 2022 if he/she holds a valid International G Karting Licence (Article 3.4.2 of the FIA International Karting Licences for Drivers).

3.3.2 Weight Limit

Minimum weight of kart + driver (in full race gear) is **145 kg**
Recommended minimum driver weight is 40kg (recommended minimum height 145cm)

3.3.3 Numbers

Yellow plate (22cm sides) with black numbers (at least 15cm high with 2cm stroke) Range of numbers 200 to 299.

3.4 SENIOR MAX

3.4.1 Age Limits

Age range 14 yrs and above

Competitors must be at least 14 years of age.

3.4.2 Weight Limit

Minimum weight of kart + driver (in full race gear) is **160 kg**.

3.4.3 Numbers

Yellow plate (22cm sides) with black numbers (at least 15cm high with 2cm stroke) Range of numbers 300 to 399.



MENA KARTING CHAMPIONSHIP NATIONS CUP



3.5 DD2

3.5.1 Age Limits

Age range 15yrs+

Exceptionally, 14 year old drivers are eligible to compete if they (1) have their 15th birthday before/during 2022 and (2) weigh at least 60kg.

3.5.2 Weight Limit

Minimum weight of kart + driver (in full race gear) is **175 kg**

3.5.3 Numbers

Yellow plate (22cm sides) with black numbers (at least 15cm high with 2cm stroke) Range of numbers 400 to 499.

3.6 DD2 MASTER

3.6.1 Age Limits

Age range 31yrs+

Competitors must be at least 31 yrs. and have their 32nd birthday before or during 2023.

3.6.2 Weight Limit

Minimum weight of kart + driver (in full race gear) is **175 kg**

3.6.3 Numbers

Yellow plate (22cm sides) with black numbers (at least 15cm high with 2cm stroke) Range of numbers 500 to 599.

3.7 MENA RD1 ELITE ENDURANCE AND SPRINT

For both MENA RD1 ELITE Endurance and MENA RD1 ELITE Sprint categories, drivers must be a **minimum of 15 years of age** and have a **minimum weight of 55kg** (see also Article 2.3.2).

3.8 ENGINES

In accordance with MENA Karting Championship Technical Regulations 2023 and the Event Supplementary Regulations.

4 SUPPLEMENTARY PROVISIONS – MENA ROTAX MAX CHALLENGE CLASSES ONLY

4.1 TYRES

4.1.1 Eligible Tyres

Only the following tyres may be used (see also event Supplementary Regulations):

- VEGA M1 – Micro MAX, Mini MAX
- VEGA XH3 – Junior MAX, MAX, DD2, DD2 Master

4.1.2 Quantity of Tyres

Practice – each MENA Rotax MAX Challenge competitor will be provided with ONE set of tyres free of charge for use during official practice days (Wednesday 13th and Thursday 14th December 2023). Additional sets can be purchased from the organisation as required, subject to availability.

Race – the maximum number of slick tyres permitted across the 2 official event days is TWO complete sets (4 front, 4 rear). This covers Day 1 (Qualifying and 3 Heats on Friday 15th December 2023) and Day 2 (Warm-up, Pre-Final and Final on Saturday 16th December 2023).

Each MENA Rotax MAX Challenge competitor will be provided with ONE set of tyres free of charge for use during official race days.

Optionally, competitors can pre-order a 2nd set of tyres from the organisation.



MENA KARTING CHAMPIONSHIP NATIONS CUP



4.1.3 Pre-Ordering of Tyres

Competitors requiring a second set of race tyres should order these in advance from the organisation. These must be paid for during registration. The organisation cannot guarantee to supply additional tyres that have not been pre-ordered. A limited number of practice tyres will be available from the circuit shop on a first-come-first-served basis.

4.1.4 Tyre Marking

Each race tyre will be marked/scanned in advance by the Organisers. It is mandatory to use marked tyres during every session of the race meeting from Qualifying onwards. Tyres will be scanned throughout the event. It is the responsibility of the driver to ensure that he/she participates in all sessions with marked tyres. Any competitor found to be competing on unmarked tyres or deemed by the Panel of Stewards to have deliberately attempted to falsify such markings in an attempt to gain an unfair advantage, will be disqualified from the race and may be disqualified from the entire meeting.

4.1.5 Tyre Collection

According to pre-orders (see 4.1.3), batched and marked tyres will be made ready for collection at the time indicated on the official race schedule for the event. Competitors should double-check that each tyre is marked clearly and appropriately at the time of collection.

4.1.6 Tyre Replacement

Additional tyres are not available throughout the meeting in accordance with 4.1.2 and 4.1.3. However, in the event of a tyre sustaining accidental damage (e.g., puncture or manufacturing related failure) it must be presented for inspection to the Chief Scrutineer who (in conjunction with the Technical Delegate) will be responsible for deciding whether a replacement tyre can be issued by the organisation (see also 4.1.4). Where this is permitted, the replacement tyre must be fitted to exactly the same corner of the kart as the tyre that sustained the damage.

4.2 FUEL

The organisation will supply all premixed fuel/oil for the event as well as a 20-litre container for storage of fuel during the event. Competitors will be required to present this container at the end of each day at Parc Ferme for replenishment of fuel for the following day. Specific instructions concerning fuel handling arrangements will be communicated at official Driver Briefings and/or through an official Bulletin.

4.3 TRANSPONDER

4.3.1 Transponder General

It is the driver's responsibility to ensure that the transponder is always fitted securely and in the correct position when racing, as well as being sufficiently charged. Failure to do so may result in either loss of the transponder or intermittent (or zero) function which could lead to non-classification.

The use of the transponder is always mandatory from the first non-qualifying practice session of each driver until the Final.

4.3.2 Transponder Hire/Purchase

Transponder hire will be charged at QAR 150 and transponders will be distributed at registration. A deposit will be required at the time of hire. This may be in the form of cash/cheque to the value of QAR 2000, the competitor's valid Race Licence or another acceptable item of value as specified in the Supplementary Regulations.

The driver/entrant is liable for the full cost of the transponder (**total QAR 2000**) in the event of any loss or damage sustained during the hire period, howsoever caused.

There are a limited number of transponders available for hire. These will be allocated as Entry Forms are received on a first-come, first-served basis. Any entry received after all hire transponders are allocated will need to buy a transponder.



MENA KARTING CHAMPIONSHIP NATIONS CUP



Transponders are available for purchase at QAR 2000 per unit. This includes a charger, user manual and fixing kit. Please check in advance with the race organizer for availability.

4.3.3 Transponder Fitting

It is Organisers responsibility to mount the transponder holder in the correct position. The onus will be on the Entrant/Competitor to ensure that the transponder is securely fitted in the original mounting location (as provided by the Organiser) throughout the duration of the competition. The transponder must be mounted in an approximately upright position (i.e., the "R" clip at the top) on the back of the seat. It should be secured at a height of 25cm \pm 5cm. This height can be measured from the ground to any part of the transponder.

4.3.4 Transponder Failure

In case a transponder failure is identified by the Officials during a race, the competitor will receive a mechanical failure flag and be expected to retire from the session.

It is not the responsibility of the Officials to monitor individual timing issues. Where such issues are not identified during the race, the final classification will remain as per the official timing system report, regardless of what circumstances led to the failure.

For point scoring purposes, competitors will be considered as having started the race.

4.4 RECORDING EQUIPMENT

Personal Go Pro cameras (or similar) are not permitted to be used during racing or Qualifying. Competitors can request permission from the chassis supplier to install such recording devices during non-qualifying practice sessions. If agreed, competitors must then receive approval from the Scrutineers regarding its safe mounting/installation.

4.5 FLOOR MATS

The use of floor mats (or suitable equivalent floor covering) beneath karts when work is being carried out is mandatory throughout practice and race days. This prevents problematic, unsightly and costly tarnishing of paddock areas belonging to the host venue. The organisers reserve the right to eject from the paddock area any competitor who fails to observe this ruling and/or may insist that the offender purchase/hire appropriate floor protection if immediately available.

4.6 ENGINE RUNNING

Engines must not be run in the pits or paddock at any time. The Chief Scrutineer may permit a competitor to start their engine in a designated area only, as identified by the Chief Scrutineer. However, engines may be run for a maximum of 5 seconds in a designated area adjacent to the Pre-Grid, for the sole purpose of confirming fuel flow and prior to taking up the competitors' position on the Pre-Grid to participate in a session or race. Any unauthorised engine running will be reported to the Stewards and offenders shall be liable to a fine or QAR 250.

5 TECHNICAL REGULATIONS

5.1 GENERAL

The **MENA Karting Championship Technical Regulations 2023** apply to MENA Rotax MAX Challenge categories. Amendments may be made at any time by way of official Bulletins or Event Supplementary Regulations which will be posted on the Official Notice Board. FIA Karting Regulations apply to all safety issues except where otherwise stated.

Karts are only allowed to race if they are in a condition which meets FIA Karting safety standards and if they comply with the regulations. They must be maintained in such a way as to not represent a danger to the driver or other participants/spectators.

Remember **"ANYTHING WHICH IS NOT EXPRESSLY ALLOWED IS FORBIDDEN."**

5.2 KARTS

Identical chassis and engines are supplied by the organisation and its partners to promote a level playing field throughout the MENA Karting Championship. Only components provided by the organisation and available to all competitors can be used.

See also Event Supplementary Regulations.



MENA KARTING CHAMPIONSHIP NATIONS CUP



6 SAFETY EQUIPMENT

6.1 MENA ROTAX MAX CHALLENGE

All safety wear for MENA Rotax MAX Challenge classes (helmet, gloves, boots, race suits) must be approved under the FIA Karting Technical Regulations, Article 7.

6.2 MENA RD1 ELITE ENDURANCE AND SPRINT

It is highly recommended that all safety wear (helmet, gloves, boots, race suits) is approved under the FIA Karting Technical Regulations, Article 7.

6.2.1 Crash Helmet

Drivers must wear a helmet with efficient and unbreakable protection for the eyes.

All helmets must be full-face and fitted with visor. Visors should be closed when driving. Dark visors are only permitted during daylight hours. Clear visors are mandatory after sunset.

The helmet does not have to meet FIA Karting standards but this is highly recommended. An alternative is a British or European standard for road use. Open face helmets are not acceptable.

6.2.2 Race Suit

Race suits are mandatory. Ideally the suit should meet 'Level 2' specification but it does not have to be within the defined homologation period. It must be in good condition.

6.2.3 Gloves

Gloves are mandatory. They must be in good condition and must completely cover the hands and fingers.

6.2.4 Boots

Drivers **MUST** wear suitable flat-soled footwear. Sandals, high heels or open-toed footwear will not be permitted. It is recommended (but not compulsory) that the footwear also provides ankle protection.

7 REGULATORY AMENDMENTS

QMMF Reserves the right to issue additional statements concerning the Rules and Regulations from time to time. All such statements will be issued to all registered competitors by means of the Event Supplementary Regulations or Competitors' Bulletins.

8 ADVERTISING ON KARTS, OVERALLS AND HELMETS

Competitors will be obliged to carry official MENA Karting Championship stickers and sponsor logos on their karts, race suits and helmet. Any such advertising material will be provided by the Organizers along with instruction on positioning as necessary.

Competitors are responsible for the presentation and preservation of sponsor stickers/logos. The organiser will provide 1 complete set of stickers to each competitor free of charge. Lost/damaged stickers must be replaced at the expense of the competitor. Competitors may be required to remove decals/stickers and other advertising which may conflict with the series sponsors. Competitors may be required to take part in further promotional activities at the rounds or the prize giving. Prize winners may be obliged to wear a sponsor cap, if supplied by Race Organiser, during the award presentation. All drivers receiving awards at the post-race presentation should wear their race suit (zipped up with collar fastened) and race boots. Failure to comply with the Organiser's instructions could lead to exclusion from the results/event.

9 USE OF THE TRACK AND OVERTAKING

The descriptions below should be viewed as complementary to Article 13.

9.1 USE OF THE TRACK

During each on-track session of the Race Meeting, drivers may use the track only and must at all times observe the dispositions of the Code relating to driving on circuits.



MENA KARTING CHAMPIONSHIP NATIONS CUP

The circuit is defined by the white lines on both sides of the track. For clarification, the kerbs are not part of the track. Drivers are allowed to use the whole width of the track between (and including) these white lines. If the four wheels of a kart are outside these lines, the kart is considered as having left the track.

During a race a kart alone on the track may use the full width of the said track. However, as soon as it is caught up by a kart which is either temporarily or constantly faster, the driver is not allowed to move from one side to the other or make a move sideways in order to prevent a legal overtaking manoeuvre when the other competitor is already alongside (see 9.2.1).

Curves, as well as the approach and exit zones thereof, may be negotiated within the limits of the track.

9.2 OVERTAKING/DEFENDING

9.2.1 General

Overtaking, according to the circumstances, may be done either on the right or on the left. However, manoeuvres liable to hinder other drivers such as premature or dangerous changes of direction, more than one change of direction, weaving on a straight or deliberate crowding of karts towards the inside or the outside of a curve (or straight), are strictly prohibited. Such offences shall be penalised, according to the significance (and/or repetition of the offences) by penalties ranging from a fine to exclusion from the race (see also Articles 12 and 13).

In general, ONE move across the track in defence of a position between any two corners is acceptable as long as this move is not erratic. Also, it is imperative that fellow competitors are given racing room at all times. The following illustrations should aid understanding of the below points relating to overtaking.

- Where the front bumper of a kart has reached the point of being alongside (or further forward) than the rear wheel protection of another kart, 'overlap' exists.
- 'Passing overlap' is used to describe the scenario where the front wheels of a kart are in line with (or beyond) the rear wheels of another kart.

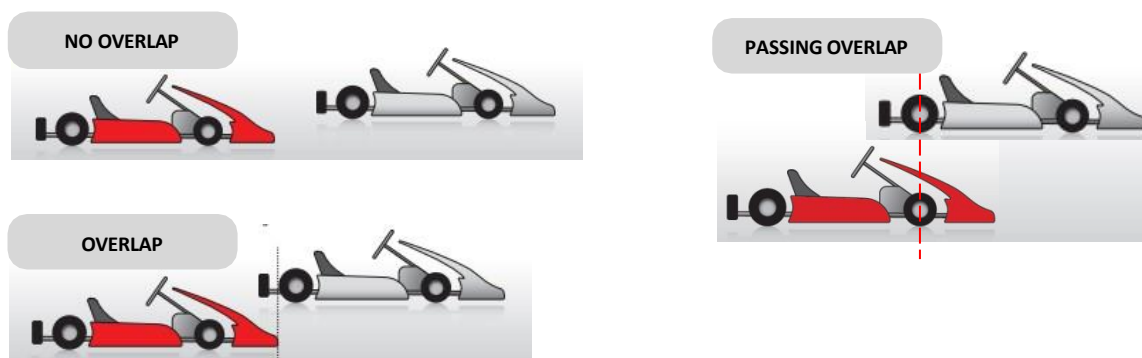

9.2.2 Corner Approach

Blocking is not permitted (see Article 13.8). If a driver has committed to the racing line at the initial braking point of the approaching corner, he/she may not move across to block the inside line during the braking phase. He/she must not interfere with a kart trying to overtake, particularly if there is an 'overlap'.

If a driver intends to use the inside line on the approach phase to a corner in defence of a position, he/she must do so prior to the initial braking point. He/she may not subsequently move out to cover the racing line from a kart trying to overtake, particularly if there is an 'overlap'.

If a driver has a slow run out of the previous corner (for whatever reason), he/she may move across to cover the line as long as:

- A. It is safe to do so.



MENA KARTING CHAMPIONSHIP NATIONS CUP



- B. The move is not erratic.
- C. Any kart with an 'overlap' is given sufficient racing room (at least one kart width to the edge of the track).

9.2.3 Corner Entry

If the kart making a pass on corner entry (the turn-in point) has a 'passing overlap' with another kart, then the kart being overtaken must not turn-in to the apex without allowing racing room (see also Article 13.3).

In general, the onus is on the overtaking kart to execute a pass safely. Overtaking karts should not expect the kart in front to give way unless there is a 'passing overlap' at the turn-in point of the corner (see also Article 13.4).

A Kart that arrives at the turn-in point with a 'passing overlap' but is considered to be out of control (e.g. smoke off the tyres, etc.) will be deemed not be in a position to make a safe pass.

9.2.4 Corner Exit

Racing room should also be given on the exit of a corner. Contact with the back of another kart, unsettling it on corner exit, is not permitted.

If the kart in front is 'nudged' wide and loses position this would be considered a breach and could incur a penalty (see also Article 13.6).

9.3 BEING LAPPED

A kart alone on the track may use the full width of the track. However, as soon as it is caught by a kart which is about to lap it the driver must allow the faster driver past at the first possible opportunity. Blue flags will be used in this case to prepare the slower driver for this situation. Failure to observe the blue flags is an offence which will be referred to the Stewards.

10 GENERAL SAFETY

- A. It is strictly forbidden for drivers to drive their karts in a direction opposite to that of the race, unless this is strictly necessary to remove the kart from a dangerous situation.
- B. During each on-track session of the Race Meeting, a kart that stops must be removed from the track as rapidly as possible in order for its presence not to constitute a danger or be an impediment for other drivers. If the driver is unable to remove the kart from a dangerous position by driving it, he/she will be required to exit the kart when it is safe to do so and remove it to a place of safety. Marshals may assist if instructed to do so by the Clerk of the Course (see 2.8.4). Except for medical or safety reasons, the driver must stay close to his/her kart until the end of the Race.
- C. If a repair area is provided, any repairs with tools are banned outside the zone. It is forbidden to take any tools and/or spare parts on board the kart. The driver can receive help only in the Repairs Area determined by the Supplementary Regulations or during the briefing.
- D. Except in cases expressly provided for by the Regulations or by the Code, no one except the driver is authorised to touch a stopped kart before reaching the scales.
- E. When the track is closed by the Race Direction after the Qualifying/Race finish (until all concerned karts, whether they are mobile or not, have arrived at the scales or at the Parc Fermé) no one is allowed to access the track, with the exception of Marshals carrying out their duties and of drivers when they are driving.
- F. A speed limit of 5 km/h is imposed in the pit lane at all events. Any driver deemed to be exceeding this speed limit will be liable to sanctions provided for in the Regulations.
- G. If a driver is involved in a collision, he/she must not leave the circuit without the Stewards' agreement.



MENA KARTING CHAMPIONSHIP NATIONS CUP

QMF
الاتحاد القطري للسيارات والدراجات النارية
QATAR MOTOR & MOTORCYCLE FEDERATION

- H. No driver may leave the Parc Fermé Area without permission from the Chief Scrutineer.
- I. The driver of any kart leaving the race shall signal this intention in good time and is responsible for ensuring that the manoeuvre is carried out safely and as near as possible to the Pit Entry.
- J. Any driver who intends to leave the track by means of the Pit Lane shall demonstrate his/her intention in due time and shall ensure that he/she does so safely.
- K. In each session of the Race Meeting, drivers must at all times wear the full equipment defined under Art.6 of these Regulations (Art.7 of the FIA Karting Technical Regulations).
- L. It is forbidden to circulate with motorbikes, scooters or any other motorised devices in the Paddock. This applies to skateboards, bikes/scooters, Segways, wheelbarrows, pogo- sticks and other such equipment by extension. The driving of karts in the Paddock Area is forbidden under all circumstances.
- M. In the unusual case of rain, slick tyres will continue to be used. Racing will continue as normal at the discretion of the Race Director or Clerk of the Course in collaboration with the Chairman of the Stewards. Normally, racing will only be halted if driving conditions become dangerous, e.g., in the case of standing water. It is assumed that drivers will be able to recognise wet conditions due to the appearance of rain drops on their visors.
- N. It is the Entrant's responsibility to ensure that all persons concerned by his/her Entry observes all the provisions of the Code, the Technical Regulations and the Sporting Regulations. If an Entrant is unable to be present in person at the event, he/she must nominate a representative in writing. The person having charge of an entered kart during any part of an event is responsible jointly with the Entrant and/or separately for ensuring that the provisions are observed.
- O. Entrants must ensure that their karts comply with the conditions of conformity and safety throughout the Event. The presentation of a kart for scrutineering will be deemed an implicit statement of conformity.
- P. It is imperative that, when seated in the kart, drivers are positioned so as to enable full and proper use of the steering wheel and pedals without overstretching. Further, the driver's eye-level in relation to the top of the steering wheel and Nassau Panel must permit adequate visibility straight ahead.
- Q. It is forbidden for a driver (or any child) to be seated in a kart while it is balanced on a kart trolley, whether the trolley is in motion or stationary.
- R. Tail lifts are dangerous when left partially raised. Competitors and teams must ensure that vehicle tail lifts (and tail gates) in the paddock are either fully retracted or fully lowered so that they do not pose a hazard to other paddock users. Any trailer/vehicle protrusions (e.g. tow hooks) should be properly protected to avoid accidental injury.
- S. Parents are reminded of their responsibility to monitor and control their children at all times during a practice/race day. The venue (and paddock) is not a playground. Children should behave appropriately and should not be left unattended. Failure to observe this could lead to a fine or penalty being applied to the entrant or licence holder to which the offending party is linked.

11 CODE OF CONDUCT

- A. All participants must play by the rules and respect race officials and their decisions.
- B. All participants must respect the rights, dignity and value of their fellow participants regardless of gender, ability, physical appearance, cultural background or religion.
- C. All participants must take responsibility for their actions at all times and communicate behavioural responsibilities to members of their family, team and support crew.



MENA KARTING CHAMPIONSHIP NATIONS CUP



- D. All participants are required to display courtesy and etiquette to other members and participants in training, testing and race events. Any disputes or problems that may arise during an event must be addressed in a respectful manner to the appropriate person (official) at the event.
- E. Drivers must take the time to read and fully understand the posted rules, regulations and conditions for any race event prior to its commencement. Requests for clarification of such regulations should be asked during the Drivers' Briefing.
- F. All participants must have respect for the environment, the hosting venue, spectators and the surrounding inhabitants. Responsibility must be taken to reduce excessive noise and keep all areas that are used as clean and presentable as possible.
- G. Drugs and alcohol are strictly prohibited during training, testing and races. Consumption of such substances during these times is a serious offence. Offenders will be disqualified from the event and face further disciplinary action.
- H. Abusive comments on any social media platform (Facebook, Twitter etc.) or public forum are completely forbidden. This applies to competitors, teams, officials, organisers and any person associated with the series and the sport in general. Competitors are strongly advised to guard against participation in contentious, divisive and potentially damaging conversations and will be held liable for their actions.
- I. Further to 11H, social media posts relating to the MENA Karting Championship, or any element therein, must be proactive, informative, or positive. Competitors, teams and associates should avoid posting negative comments about anyone other than themselves. Any party in breach of this rule is liable to bring the series and, by association, the sport into disrepute. Action will be swift on such matters and could result in expulsion from the Championship for the offender, whether individual, team, mechanic, circuit or official. In the case that the offender is not a registered competitor, action may be taken against any party associated with the offender.

12 INCIDENTS

An "Incident" means a fact or a series of facts involving one or several drivers (or any Driver's action reported to the Stewards by the Clerk of the Course or noted by the Stewards and reported to the Clerk of the Course for investigation), who:

- A. provoked the stopping of a Race
- B. violated these Sporting Regulations or the Code
- C. jumped the start or started from an incorrect position
- D. did not respect flag signalling
- E. caused one or several karts to take a false start
- F. caused a collision
- G. forced another driver out of the track
- H. had the front fairing on the kart in the incorrect position
- I. illegally prevented a legitimate passing manoeuvre by a driver
- J. illegally impeded another driver during a passing manoeuvre
- K. leaving or working on their kart in a dangerous position

The Stewards shall inflict a time or position penalty on any driver having caused an incident. If the incident was caused during a qualifying practice session, they shall proceed to the cancellation of the three fastest times which he/she achieved in the session concerned. However, considering its serious nature, the stewards may decide, instead of (or as well as) the time/position penalty, of a sanction among those provided for in the penalty scale of Article 12.4 of the International Sporting Code. Typical penalty scenarios can be seen in Article 13.



MENA KARTING CHAMPIONSHIP NATIONS CUP

13 PENALTY CATALOGUE

13.1 FALSE START

TYPE A – A kart on the formation lap approaching the start line has two wheels on or outside the tram lines before the red lights are switched off to start the race (as depicted by kart number 2 in the right illustration).

Penalty: 3 seconds

TYPE B – A kart on the formation lap approaching the start line has all four wheels outside the tram lines before the red lights are switched off to start the race.

Penalty: 10 seconds

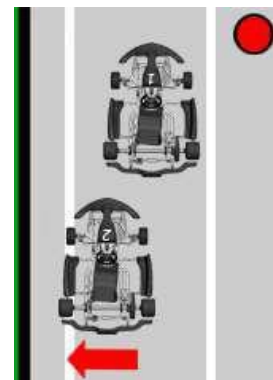

13.2 JUMP START

A **JUMP-START** is declared by a Judge of Fact when a kart either (1) has accelerated prematurely before crossing the yellow acceleration line and/or before the red race start lights have been switched off, and/or (2) is ahead of its prescribed position at the time the start signal is given (as depicted by kart number 2 in the left illustration).

Penalty: 10 seconds

Note: The penalty may be applied against the offending driver(s) even if the start is aborted and declared a "FALSE START". This is at the discretion of the Clerk of the Course.

If one driver is guilty of causing multiple false starts then the race direction may apply a penalty at their discretion which could be relegation to the back or a time penalty as specified above.

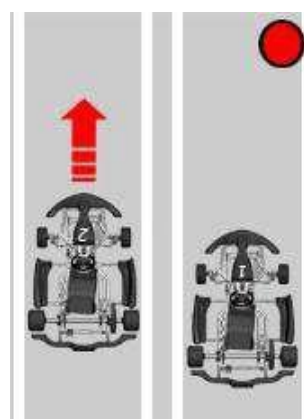

13.3 CUTTING-IN

This is where a kart (kart number 1 in the illustration) is positioned on the outside of kart 2 and either partially/completely cuts across the racing line of, or otherwise impedes, kart 2 during a legitimate overtaking manoeuvre. This applies to the corner entry, apex and exit.

For 'cutting in' to be considered, kart 2 must be positioned so that its front wheels are at least alongside the rear wheels of kart 1 (as depicted in the right illustration). Kart 2 must be under control.

An advantage is gained if (either/or):

- Kart 2 suffers a loss of position or fails to finish as a direct consequence of the manoeuvre.
- Kart 2 suffers damage which results in a loss of position or is forced to retire from the race on the same lap.
- Kart 1 maintains his/her position when he/she would have otherwise lost it.

Penalty (no advantage gained): Warning/Reprimand
Penalty (advantage gained): Minimum 5 seconds

Note: The penalty shall be applied irrespective of whether there was any contact between the karts or not.

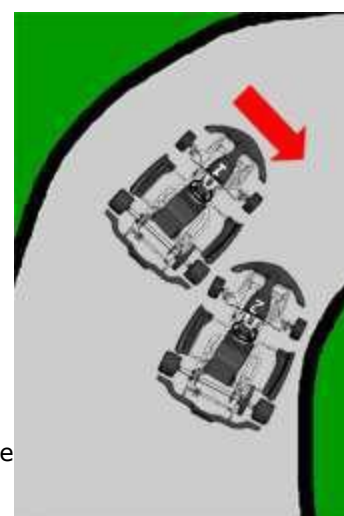



MENA KARTING CHAMPIONSHIP NATIONS CUP

13.4 DIVING UP THE INSIDE

This is where a kart (*kart 2 in the illustration*) attempts to overtake kart 1 on the inside despite there being insufficient track space available (including the inner kerbs and areas outside the track limits) to safely complete the manoeuvre. The position of each kart relative to each other is irrelevant.

An advantage is gained if (either/or):

- Kart 2 gains a position
- Kart 1 suffers a loss of position or fails to finish as a direct consequence of the manoeuvre.
- Kart 1 suffers damage resulting in (a) loss of position(s) or is forced to retire from the race on the same lap.

Penalty (no advantage gained): Warning/Reprimand

Penalty (advantage gained): Minimum 5 seconds

Note: The penalty shall be applied irrespective of whether there was any contact between the karts or not and regardless of whether the overtaking manoeuvre was completed or not.

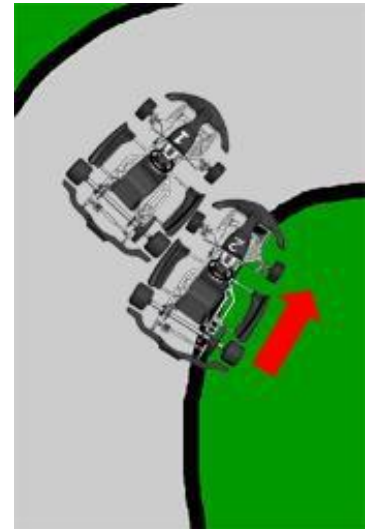

13.5 CROWDING, PUSHING or SQUEEZING

This is where one kart (*kart 1 in the right illustration*) forces kart 2 wide towards the track limits or partially/completely beyond the track limits.

The proviso is that kart 2 is positioned so that its front wheels are at least alongside the rear wheels of kart 1 (as depicted in the illustration).

An advantage is gained if (either/or):

- Kart 1 maintains his/her position when he/she would have otherwise lost it.
- Kart 2 suffers a loss of position or fails to finish as a direct consequence of the manoeuvre.
- Kart 2 suffers damage resulting in (a) loss of position(s) or is forced to retire from the race on the same lap.

Penalty (no advantage gained): Warning/Reprimand

Penalty (advantage gained): Minimum 5 seconds

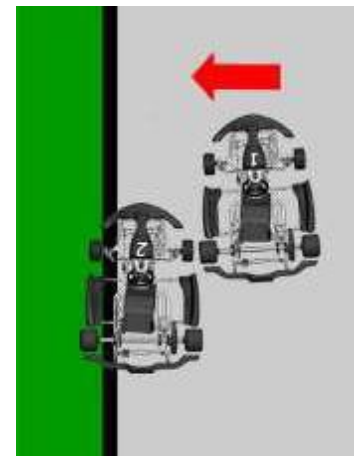

13.6 BUMPING or CONTACT

This is where one kart (*kart 2 in the right illustration*) causes avoidable contact with another kart (involving either front to rear or side-to-side impact).

Only the consequences of the impact are relevant in judging whether an advantage has been gained or not. The severity of the impact is largely inconsequential.

An advantage is gained if (either/or):

- Kart 2 gains a position and the previous order is not restored during the same lap.
- Kart 1 suffers a loss of position or fails to finish as a direct result of the contact.
- Kart 1 suffers damage resulting in (a) loss of position(s) or is forced to retire from the race on the same lap.

Penalty (no advantage gained): Warning/Reprimand

Penalty (advantage gained): Minimum 5 seconds

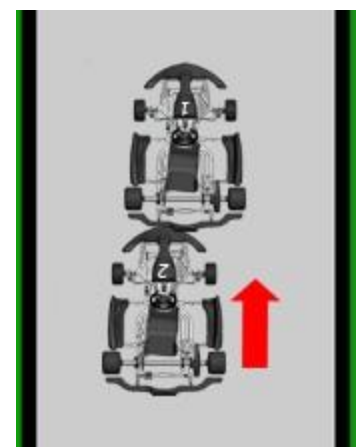



MENA KARTING CHAMPIONSHIP NATIONS CUP

13.7 SHORT-CUTTING OR EXCEEDING CIRCUIT LIMITS

This is where one kart (kart 2 in the right illustration) exceeds the track limits completely and returns to the racing surface at a different point further along the track either via a shorter distance or with greater speed as a result of the breach (e.g., utilising run-off areas to gain time). The reasons for leaving the track are irrelevant.

An advantage is gained if (either/or):

- Kart 2 gains a position and/or time which cannot be redressed during the same lap.
- Kart 2 maintains his/her position when he/she would have otherwise lost it.
- Another kart is impeded or otherwise handicapped by a kart re-joining the circuit after exceeding the track limits.
- Another kart suffers (a) loss of position(s) or is forced to retire from the race as a direct result of the re-entry of a kart which has exceeded the track limits.

Penalty (no advantage gained): Warning/Reprimand

Penalty (advantage gained) Minimum 5 seconds

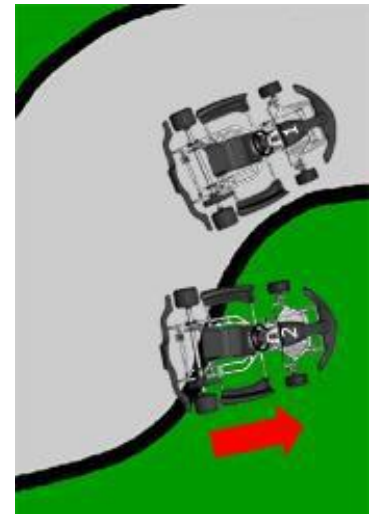

13.8 WEAVING or BLOCKING

This is where a kart (kart 1 in the right illustration) changes its lateral position / racing line on a straight by more than a kart's width, twice or more.

The distance between the karts involved and whether the chasing kart would have been able to complete an overtaking manoeuvre is irrelevant.

An advantage is gained if (either/or):

- Kart 1 maintains his/her position when he/she would have otherwise lost it.
- Kart 1 performs such a manoeuvre more than once during the same race.

Penalty (no advantage gained): Warning/Reprimand

Penalty (advantage gained): Minimum 5 seconds

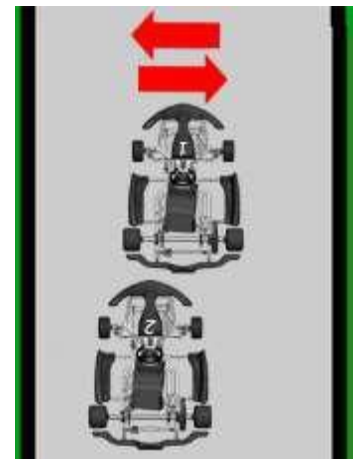

13.9 TECHNICAL INFRINGEMENT

This occurs when a kart and/or engine does not meet the stipulated technical regulations or specifications.

It is irrelevant if the technical infringement was discovered before, during or after a qualifying session or a race, and whether the technical infringement would have led to any advantage being gained.

Only the condition and specification of the kart / engine at the time of the official examination will be considered.

Typical examples of a technical infringement might include:

- Being underweight
- Using incorrect fuel, oil, coolant etc.
- Using modified parts
- Use of unmarked tyres.

Penalty: Disqualification



In case of a protest against the eligibility of another competitor or their equipment, such a protest must be lodged within 30 minutes of the alleged ineligibility becoming apparent.



MENA KARTING CHAMPIONSHIP NATIONS CUP

13.10 FORMATION LAP OFFENCES

A. A kart on the formation lap improves its starting position after having crossed the red formation line and before the start signal is given (as depicted by kart number 2 in the right illustration).

Penalty: Disqualification

B. A kart on the formation lap attempts to make up time or positions by taking a short-cut (any course other than the track used during the race) to regain its original position (see Article 2.6.3).

Penalty: Disqualification

C. A driver fails to remove his/her kart to a safe position in a timely manner after stopping on the formation lap and being unable to continue (see Article 2.6.3).

Penalty: Grid penalty in future race

13.11 IGNORING FLAG SIGNALS

This is self-explanatory and is when a driver fails to observe the requirements of a particular flag being displayed by race officials.

The type of flag and the reason(s) why the flag was not obeyed is irrelevant along with whether any advantage was gained or not.

Typical examples of ignoring flag signals might include:

- Overtaking under a yellow flag (as depicted by kart number 2 in the right illustration).
- Continuing to race after receiving a black/orange or black flag or red flag.
- Failing to comply with the blue flag requirements when being lapped.

Penalty: Minimum 5s up to Disqualification

13.12 CAUSING A COLLISION

This is where one kart, regardless of its position on or off the track, and regardless of the proximity (or not) of other karts, and regardless of whether or not any contact occurred, is deemed to have been responsible for causing a collision.

Only the consequences of the incident are relevant in judging whether an advantage has been gained or not.

An advantage is gained if (either/or):

- The driver gains time or (a) position(s) and the previous order is not restored during the same lap.
- Another driver(s) suffers a loss of time or position or fails to finish as a direct result of the incident.

Penalty (no advantage gained): Warning/Reprimand

Penalty (advantage gained): Minimum 5 seconds

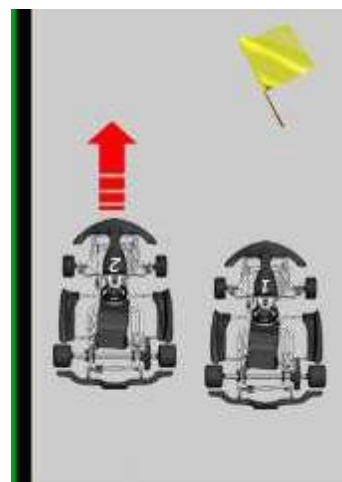
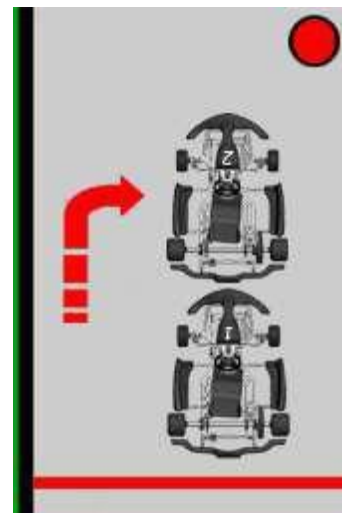



MENA KARTING CHAMPIONSHIP NATIONS CUP

13.13 FRONT FAIRING MOUNTING KIT

Where the CIK-homologated detachable front fairing mounting kit is used, it must at all times during live sessions be fitted and maintained in the correct position in accordance with Article 2.3.3 of the FIA Karting General Prescriptions and Technical Drawing 2.2 and 2.2.1.

TYPE A – DETACHMENT – A Judge of Fact reports the front fairing of a kart to be in an unacceptable position as defined by Competitor Bulletin 18042901 (*and shown in the right illustration*)

Penalty (Race): 5 seconds

Penalty (Qualifying): Deletion of fastest lap

Note: The above penalty is mandatory and indisputable for front fairing non-compliance only. Drivers may be referred to the Stewards for offences that gave rise to the non-compliance.

TYPE B – ILLEGAL REPLACEMENT – At any time during any live session, from Pre-Grid until post-race weighing of the kart, it is found that a Driver (or third party) has attempted to refit or has successfully refitted a front fairing that was not correctly positioned.

Penalty: Disqualification from the Competition

Note: This decision is not subject to appeal.

NOTE:

The above examples provide A GUIDE as to how penalties are applied to competitors for specific offences. However, each incident must, by necessity, be judged on its own merits and additional penalties may be applied by the Senior Officials as they deem fit, with harsher penalties likely for repeat offenders.

Where appropriate penalties cannot be applied to the session/race in which the offence occurs the Senior Officials reserve the right, at their sole discretion, to carry forward a representative penalty to the driver's next session, race or event. This may involve invoking grid place penalties or alternative sanctions as circumstances dictate, including the deduction of Championship points.

Where it is established that Competitor A has been disadvantaged as a direct result of the actions of Competitor B, the Senior Officials will often look to redress the disadvantage by penalising Competitor B such that [as a minimum] he/she finishes behind Competitor A in the final race classification, even if such a penalty is outside the guidelines given above.

In all cases, the Clerk of Course / Stewards will formally notify the driver of the offence, the resulting penalty decision and the intention to carry forward the penalty to his/her next session, race or event. Any driver/entrant refusing to sign a legitimate penalty notice may forfeit all Championship points gained during the event and may be subject to further sanctions.

Conduct will be monitored throughout the Championship and offences recorded. Persistent misconduct is likely to result in the additional deduction of Championship points.

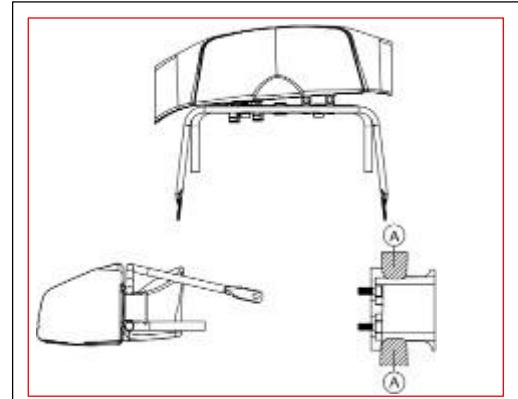

THE FRONT FAIRING IS NOT IN AN ACCEPTABLE POSITION IF ANY PART OF THE TUBES OF THE FRONT BUMPER ARE IN THE AREA 'A'.



MENA KARTING CHAMPIONSHIP NATIONS CUP



Terminology that may be used when referring to driving standards:

Careless Driving – departing from the standard of a competent driver.

Reckless Driving – any unintentional action by a driver which creates serious risk to others.

Dangerous Driving – any intentional action by a driver which creates serious risk to others.

13.14 SUMMARY OF PENALTIES

ARTICLE	OFFENCE	RECOMMENDED PENALTY
13.1	2 WHEELS OUTSIDE TRAMLINES BEFORE START SIGNAL	3 s ADDED TO RACE TIME
	4 WHEELS OUTSIDE TRAMLINES BEFORE START SIGNAL	10 s ADDED TO RACE TIME
13.2	JUMP START	10 s ADDED TO RACE TIME
13.3	CUTTING IN - NO ADVANTAGE GAINED	WARNING OR REPRIMAND
	CUTTING IN - ADVANTAGE GAINED	MINIMUM 5 SECONDS
13.4	DIVING UP THE INSIDE - NO ADVANTAGE GAINED	WARNING OR REPRIMAND
	DIVING UP THE INSIDE - ADVANTAGE GAINED	MINIMUM 5 SECONDS
13.5	CROWDING, PUSHING, SQUEEZING - NO ADVANTAGE GAINED	WARNING OR REPRIMAND
	CROWDING, PUSHING, SQUEEZING - ADVANTAGE GAINED	MINIMUM 5 SECONDS
13.6	BUMPING CONTACT - NO ADVANTAGE GAINED	WARNING OR REPRIMAND
	BUMPING CONTACT - ADVANTAGE GAINED	MINIMUM 5 SECONDS
13.7	EXCEEDING CIRCUIT LIMITS - NO ADVANTAGE GAINED	WARNING OR REPRIMAND
	EXCEEDING CIRCUIT LIMITS - ADVANTAGE GAINED	MINIMUM 5 SECONDS
13.8	WEAVING/BLOCKING - NO ADVANTAGE GAINED	WARNING OR REPRIMAND
	WEAVING/BLOCKING - ADVANTAGE GAINED	MINIMUM 5 SECONDS
13.9	TECHNICAL INFRINGEMENT	DISQUALIFICATION
13.10	FORMATION LAP - GAINING POSITION AFTER RED LINE	DISQUALIFICATION
	FORMATION LAP - TAKING A SHORT-CUT	DISQUALIFICATION
	FORMATION LAP - LEAVING KART IN DANGEROUS POSITION	GRID PENALTY IN FUTURE RACE
13.11	IGNORING FLAG SIGNALS	MINIMUM 5 SECONDS UP TO DISQUALIFICATION
13.12	CAUSING A COLLISION – NO ADVANTAGE GAINED	WARNING OR REPRIMAND
	CAUSING A COLLISION – ADVANTAGE GAINED	MINIMUM 5 SECONDS
13.12	FRONT FAIRING MOUNTING KIT – DETACHED	5 s OR DELETION OF LAP TIME
	FRONT FAIRING MOUNTING KIT – ILLEGAL REPLACEMENT	EVENT DISQUALIFICATION

NOTE: THAT FOR OFFENCES COMMITTED DURING COMPETITIVE QUALIFYING SESSIONS, THE OFFICIAL'S MAY ALSO ELECT TO DISQUALIFY THE OFFENDER'S FASTEST LAP TIME(S) OR INVOKE A GRID PENALTY IN A FUTURE RACE(S).



MENA KARTING CHAMPIONSHIP NATIONS CUP



14 JUDICIAL MATTERS

14.1 STEWARDS HEARINGS

In hearings, competitors under the age of 18 years must always be accompanied by their parent/guardian or the duly nominated representative. However, the parent/guardian is only permitted to act as an observer of the proceedings. Parents and guardians can only assist a Junior Competitor in presenting his/her evidence as a mentor but must not indulge in advocacy.

For the purpose of this regulation, advocacy is defined as being "the act of arguing in favor of or supporting" a Junior Competitor.

Competitors over the age of 18 do not have the right to be accompanied by a team representative, parent or other representative, unless that person has been called by the Stewards and is acting as a bona fide witness.

14.2 RESPONSIBILITY FOR OFFENCES

In accordance with FIA-CIK regulations, a competitor will be responsible for all acts or omissions by any Participant associated with their entry at the event, and each of these will be equally responsible for any breach of these Regulations.

14.3 WRITTEN WARNING OR REPRIMAND

Notwithstanding the imposition of any other penalties, a formal reprimand may be issued by the Stewards for a breach of a Regulation that has not significantly advantaged or disadvantaged another Competitor, but in circumstances where the offender should have known better.

The issuance of a Reprimand to a Competitor will be recorded against the Licence Holder by the Stewards in a championship log.

A Competitor with three (3) or more Reprimands recorded within a twelve (12) month period, will be required to attend a Disciplinary Hearing.

The Disciplinary Hearing shall only consider the accumulation of three (3) or more Reprimands for the purposes of imposing an additional penalty and shall not reconsider the offences which resulted in the Reprimands being issued.

14.4 POINTS PENALTIES

A penalty resulting in a loss of points imposed upon a Competitor, shall only affect the points allocated to that Competitor's finishing position in the applicable Competition. This deduction of points shall also be applied to any overall Championship or Series point score.

A deduction of points from a competitor does not affect the finishing positions or points allocation of any other Competitor in the Competition or Championship.

An automatic Disqualification does not prevent the imposition of any additional penalty for the same offence.

A penalty of Disqualification does not prevent the Stewards from referring the matter to a Disciplinary Hearing for the consideration of imposing a further penalty or penalties.

A penalty of Disqualification from an Event may be appealed in accordance with the Regulations; however, this shall not alter the immediate application and effect of the penalty.



MENA KARTING CHAMPIONSHIP NATIONS CUP



14.5 JUDGES OF FACT

The Judges of Fact at each race event shall normally be the Starter, Chief Timekeeper, Scale Marshal, Barcode Officials, Grid Marshal and Chief Scrutineer.

Any other appointed Judges of Fact will be specified in the Supplementary Regulations or Competitor Bulletins.

The duty of a Judge of Fact is to decide when or whether a Kart or Driver:

- Has touched or passed a given line; or
- Exceeded a maximum limit; or
- Not conformed to a given specification; or
- Not complied with some other fact as laid down in these Regulations. A Protest cannot be made against the decision of a Judge of Fact.

A Protest cannot be made against the decision of a Judge of Fact.

15 GENERAL PROCEDURES AND INFORMATION FOR MENA RD1 ELITE CLASSES

15.1 RD1 ELITE KART INFORMATION

15.1.1 Kart Specification

The RD1 ELITE Karts in use for both Endurance and Sprint Competitions have been specifically designed to cope with the rigors of high-performance kart racing in the MENA region and are identically prepared.

The one-of-a-kind chassis, codenamed RD1 XR DD2, features adjustable pedals and adjustable seat while the powertrain utilizes a water-cooled Rotax 125 MAX EVO hybrid engine with chainless drive, generating 24hp in unrestricted form.

The RD1 ELITE karts are fitted with steering-wheel-mounted MyChron 5 data-loggers which provide drivers with an up-to-date digital display of lap time, engine speed and water temperature.

15.1.2 Kart Rotation

For both Endurance and Sprint formats, a kart rotation system is implemented whereby every incoming kart will undergo a visual and physical inspection before being cleared for a return to the circuit.

Drivers are responsible for reporting any safety or performance concerns to the technical team immediately at the end of their stint. Engine performance/temperature/speed and lap time data is reviewed after each session to identify or verify any potential issues.

SPRINT

Kart allocation will take place before each on-track session to ensure that drivers do not get the same kart twice throughout the event day. This will be explained in the Driver's Briefing.

ENDURANCE

During every trip through the Pit Lane, the incoming team driver will remove timing transponder, number(s) and any ballast weight from the kart and will, with their team, manage getting these items to the outgoing driver zone where a new kart will be used for the next driver stint.

The organisation will oversee the maintenance/repair/fuelling schedule of all RD1 ELITE karts throughout the event.



MENA KARTING CHAMPIONSHIP NATIONS CUP



15.1.3 BREAKDOWN RECOVERY AND REPAIR

Should a kart suffer a breakdown or other technical problem on track which prevents it from reaching the Pit Lane, the following procedure will apply:

- A. It is the current Driver's responsibility to get the kart to a place of safety so that it does not pose a hazard to other karts
- B. Should the kart be close enough to the Pit Lane for it to be pushed/carried back safely, the Race Director will oversee this with possible assistance from the marshals.
- C. In case a kart trolley or other vehicle is required to facilitate the return of the kart to the Pit Lane, the Race Director may choose to first neutralise the race before allowing the Team to recover the kart safely (see 2.8.5).
- D. Any damage sustained to a kart as a direct or indirect result of driver error, collision, leaving the circuit, etc, deliberate or otherwise, will be attended to by the RD1 ELITE Technical Team. In this situation, the Driver/Team may not be issued with a replacement kart until required repairs are carried out. Drivers/Teams understand that they are financially liable for any such damage sustained by the kart whilst in their care.
- E. Drivers encountering a mechanical/technical problem which is not the result of the above may be issued with a replacement kart at the discretion of the Senior Officials.

15.2 WEIGHT

15.2.1 Minimum Weight

Drivers (RD1 ELITE Sprint) and Teams (RD1 ELITE Endurance) must ensure that the minimum weight is met at all times throughout all competitive sessions of the event.

The minimum weight will be formally announced at the Driver's Briefing and published on the official Notice Board and Drivers/Teams are advised that any information delivered at the Driver's Briefing may supersede these regulations.

As a rule, the minimum weight is based on a driver weight of approximately 85 kg in combination with a kart in race trim but without fuel.

This figure refers to the total weight of driver plus kart and equipment (including ballast weight as necessary) in racing condition AT THE END OF EACH DRIVER STINT.

15.2.2 Weight Checking Procedure

A set of calibrated scales – the 'weighbridge' – will be in use throughout the event. These are located in the Pit Lane before the refuelling/technical/driver change areas. It is compulsory for each driver to stop at the Stop Line, indicated by two cones, just before the weighbridge. Drivers not stopping will be subject to a penalty. A 'judge of fact' will be present at the weighbridge at all times during the event.

Drivers may then drive slowly onto the weigh bridge, stopping again when all 4 tyres are in contact with the flat platform. The driver must remain stationary while an official record the total weight of kart and driver. Once ready, the official will signal to the driver to continue along the Pit Lane.

If the display shows the kart to be less than the minimum weight, the figure will be noted down and referred to the Race Director for further action. If narrowly underweight, drivers will be allowed 2 attempts (roll on – roll off) to re-weigh (in the Endurance race this can happen only if this does not impede another Team). Harassment of the weighbridge operator could lead to penalties.

Penalties will apply to any Driver/Team failing to meet their respective minimum weight during weighing.



MENA KARTING CHAMPIONSHIP NATIONS CUP



15.2.3 Kart Ballast Weights

Drivers failing to reach the minimum weight will be required to carry ballast weights which are available from the race organization.

Each kart has the capacity to carry up to 30kg of removable ballast weights in 5kg increments. The weight denominations are 15kg (black), 10kg (red) and 5kg (yellow).

It is the responsibility of the Driver and/or Team member(s) to install/remove ballast weights correctly and safely, taking care not to damage elements of the cooling system and electric start (both of which are closely located to the weight box).

IT IS ABSOLUTELY FORBIDDEN FOR ANY DRIVER TO CARRY WEIGHTS OTHER THAN THOSE MENTIONED SPECIFICALLY ABOVE. LOOSE WEIGHTS CARRIED IN POCKETS OR TAPED TO LIMBS ARE **UNSAFE**. ANYONE INTENDING USING A 'CAMELBAK' OR SIMILAR FOR HYDRATION PURPOSES MUST GET THIS APPROVED BY THE RACE DIRECTOR.

ENDURANCE

Each team is responsible for monitoring and installing ballast weights according to their individual driver weights and stints. These ballast weights must be returned to their original place by the incoming driver (or a fellow Team member) at the end of each stint. Failure to do so could result in a penalty.

15.2.4 Practical Weight Considerations

When determining the quantity of ballast to carry it is important to anticipate inevitable fluctuations in driver and kart weight throughout the race.

Drivers will likely lose body weight through fluid loss, particularly when exerting themselves in high temperatures. Excessive fluid loss could lead to penalties for being underweight or worse – sickness, nausea, etc. It is important to keep these fluids topped up by drinking plenty of water and other hydration drinks during the event.

Karts too can lose weight. One obvious contributor is fuel. A full tank of fuel weighs approximately 7kg so longer driving stints will use more fuel and lead to the kart reaching the weighbridge nearly 7kg lighter than when it first left the Pit Lane!!!

To a lesser extent the tyres will also become lighter through use as the rubber wears. These are fine margins but it's good to be aware!

15.2.5 Underweight

ENDURANCE

Drivers failing to meet the prescribed minimum weight will be subject to penalties according to the following scale:

Up to 5.00kg	1 lap deduction
5.01 - 10.00kg	2 lap deduction
10.01 - 15.00kg	3 lap deduction
15.01 kg+	4 lap deduction

These deductions will be applied in each instance. One of the most vital elements of race strategy is to ensure that team drivers are always above this minimum limit.



MENA KARTING CHAMPIONSHIP NATIONS CUP



SPRINT

Individual driver weights will be recorded at the start of the event to determine the amount of ballast to be carried by each competitor.

Should the minimum weight (kart + driver) as announced in the Driver's Briefing not be met at the weighbridge, the individual ballast weights being carried by the competitor will be checked.

If the competitor is found to be carrying ballast weights totalling less than specified at the official weigh-in, then a penalty will apply according to the above [ENDURANCE] scale.

Alternatively, if the competitor is found to be carrying the correct ballast weights as recorded at the official weigh-in, then this amount may be re-evaluated and increased for future sessions.

16 THE BELOW ARTICLES REFER TO MENA RD1 ELITE ENDURANCE ONLY

16.1 NUMBER OF DRIVERS PER TEAM

The **minimum** number of drivers per team is 2.

The **maximum** number of drivers per team is 3.

Exceptions to these limits will be considered at the discretion of the Event Organizers according to specific circumstances as presented by confirmed Teams.

Drivers may only race in 1 Team unless otherwise agreed by the Race Director.

16.2 ADDITIONAL TEAM PERSONNEL

Teams are responsible for their own race strategy and technical support and are encouraged to utilize additional personnel as necessary to cover these areas.

Any such personnel should also register with the Team in order to be permitted access into the Pit Lane and Technical Areas.

16.3 PIT LANE RULES

The entire Pit Lane is a NO SMOKING AREA.

Only registered Team members are permitted in the Pit Lane throughout the event.

Drivers should prepare to enter the Pit Lane by raising one arm high in the air and moving off the racing line so as not to impede other karts.

Once having entered the Pit Lane all karts must be driven at 5 km/h.

Karts must be switched off once the incoming driver zone has been reached.

The live Pit Lane, refuelling bay and scales should not be blocked at any time by Teams attempting to change drivers, carry out repairs or re-weight.

Outgoing drivers must continue at 5 km/h while in the Pit Lane. A marker will be placed to identify the official end of the Pit Lane. This will be detailed in the Driver's Briefing. Drivers should proceed with caution toward the Pit Exit.

Drivers exiting the Pit Lane MUST give way to karts already on track and should stay off the racing line until race speed is reached so as not to impede other karts.

Drivers must understand and allow for tyre, brake and engine temperatures being less than optimum at the start of the stint. Steering and pedal inputs should be adjusted accordingly.



MENA KARTING CHAMPIONSHIP NATIONS CUP



16.4 REFUELLING

The RD1 ELITE pit crew will handle all fuel.

The organization will ensure that all karts are fully fuelled for the start of Practice/ Qualifying and topped up again so that all Teams have a full tank for the race start.

During live sessions incoming drivers must stop at the refuelling zone AND switch the engine off BEFORE exiting the kart.

16.5 DRIVER CHANGES

During the briefing the Race Director may specify a MAXIMUM stint time for all Teams to adhere to. The limitations of this are purely to avoid the possibility of running out of fuel on track which could result in engine damage.

IT IS IMPERATIVE THAT ENGINES ARE NOT STARVED OF FUEL AT ANY TIME DURING OPERATION SINCE THIS COULD RESULT IN ENGINE FAILURE.

The minimum number of driver changes during the MENA RD1 ELITE ENDURANCE is 2. There is no set maximum number of driver changes per se, although the above restriction will promote the need to pit approximately once per hour for fuel.

There is no minimum time limit on driver stints.

Individual team strategy (and fuel economy) will determine the length of each stint according to the above parameters. Double stints are permitted.

The driver change procedure will be explained during the briefing.

The RD1 ELITE pit crew will monitor all Pit Lane activities, including driver changes, to ensure that the rules are adhered to.